

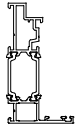

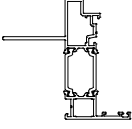

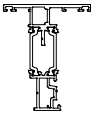

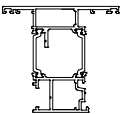

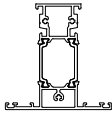
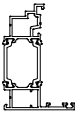
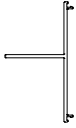
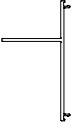



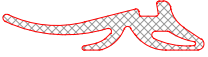

TSC 70

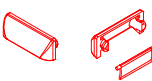

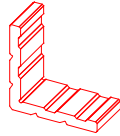
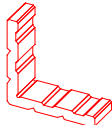
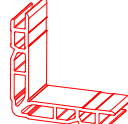
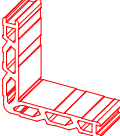
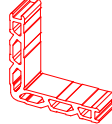
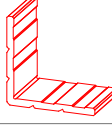

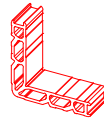
TGP SLIM CASEMENT

PROFILE SECTION	PROFILE CODE	PROFILE NAME	Jx cm ⁴	Jy cm ⁴	WEIGHT(kg/m)
	T70-85-86	FRAME PROFILE	34,02 cm ⁴	4,61 cm ⁴	1,269 kg/m
	T70-15-86	FRAME PROFILE	39,01 cm ⁴	11,27 cm ⁴	1,479 kg/m
	T70-90-89	SASH PROFILE	27,94 cm ⁴	5,57 cm ⁴	1,293 kg/m
	T70-10-11	SASH PROFILE	38,81 cm ⁴	17,95 cm ⁴	1,675 kg/m
	T70-87-88	MULLION PROFILE	37,94 cm ⁴	11,71 cm ⁴	1,585 kg/m
	T70-91-92	ADAPTER PROFILE	25,11 cm ⁴	5,98 cm ⁴	1,195 kg/m
	T70-12	NAIL FIN PROFILE	-	-	0,662 kg/m
	T70-13	NAIL FIN PROFILE	-	-	0,662 kg/m
	T70-93	GLAZING BEAD	-	-	0,316 kg/m
	T70-14	GLAZING BEAD	-	-	0,277 kg/m

TGP SLIM CASEMENT SYSTEM ACCESSORIES

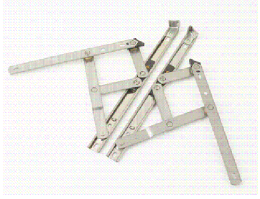
ACCESSORIES	REFERENCE CODE	DESCRIPTION	PRODUCT CODE	PACK
	T70-38	FRAME GASKET	T70-PKF.40	415 mt / pack 10 kg
	T70-94	INNER GLAZING GASKET	T70-SiCF.45	133 mt / pack 10 kg
	T70-53	OUTER GLAZING GASKET	T70-DCF.25	240 mt / pack 10 kg
	T70-57	WATER DRAIN COVER (FIXED)	T70-TK.115	1000 unit / 1 pk
	T70-56	WATER DRAIN COVER (MOVEABLE)	T70-TK.112	1000 unit / 1 pk
	T70-53	CORNER BRACKET	T70-KG.100	1 pk / 500 unit
	T70-46-26	CORNER CONNECTION WEDGE	T70-KT-2046-1930	Unit
	T70-46-27	CORNER CONNECTION WEDGE	T70-KT-2046-1130	Unit
	T70-71-08	CORNER CONNECTION WEDGE	T70-KT-2371-1080	Unit
	T70-22-57	CORNER CONNECTION WEDGE	T70-KT-5022-1930	Unit
	T70-22-58	CORNER CONNECTION WEDGE	T70-KT-5022-1130	Unit
	T70-45-09	CORNER CONNECTION WEDGE	T70-KT-2045-1930	Unit
	T70-73-03	CORNER CONNECTION WEDGE	T70-KT-14773-1130	Unit
	T70-62-05	CORNER CONNECTION WEDGE	T70-KT-1662-1930	Unit

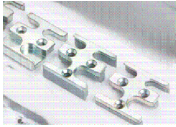
ACCESSORIES	REFERENCE CODE	DESCRIPTION	PRODUCT CODE	PACK
	T70-340	OUTWARD OPENING ESPAGNOLETTE 280 MM-HANDLE OPENING ON THE LEFT	T70-ESP-280	Unit
	T70-341	OUTWARD OPENING ESPAGNOLETTE 280 MM-HANDLE OPENING ON THE RIGHT	T70-ESP-281	Unit
	T70-342	OUTWARD OPENING ESPAGNOLETTE 400 MM-HANDLE OPENING ON THE LEFT	T70-ESP-400	Unit
	T70-343	OUTWARD OPENING ESPAGNOLETTE 400 MM-HANDLE OPENING ON THE RIGHT	T70-ESP-401	Unit
	T70-344	OUTWARD OPENING ESPAGNOLETTE 550 MM-HANDLE OPENING ON THE LEFT	T70-ESP-550	Unit
	T70-345	OUTWARD OPENING ESPAGNOLETTE 550 MM-HANDLE OPENING ON THE RIGHT	T70-ESP-551	Unit
	T70-346	OUTWARD OPENING ESPAGNOLETTE 701 MM-HANDLE OPENING ON THE LEFT	T70-ESP-700	Unit
	T70-347	OUTWARD OPENING ESPAGNOLETTE 701 MM-HANDLE OPENING ON THE RIGHT	T70-ESP-701	Unit
	T70-348	OUTWARD OPENING ESPAGNOLETTE 850 MM-HANDLE OPENING ON THE LEFT	T70-ESP-850	Unit
	T70-349	OUTWARD OPENING ESPAGNOLETTE 850 MM-HANDLE OPENING ON THE RIGHT	T70-ESP-851	Unit
	T70-350	OUTWARD OPENING ESPAGNOLETTE 1000 MM-HANDLE OPENING ON THE LEFT	T70-ESP-1000	Unit
	T70-351	OUTWARD OPENING ESPAGNOLETTE 1000 MM-HANDLE OPENING ON THE RIGHT	T70-ESP-1001	Unit
	T70-352	OUTWARD OPENING ESPAGNOLETTE 1150 MM-HANDLE OPENING ON THE LEFT	T70-ESP-1150	Unit
	T70-353	OUTWARD OPENING ESPAGNOLETTE 1150 MM-HANDLE OPENING ON THE RIGHT	T70-ESP-1151	Unit

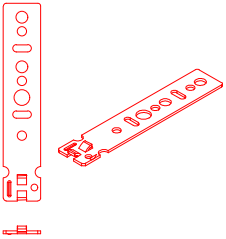
ACCESSORIES	REFERENCE CODE	DESCRIPTION	PRODUCT CODE	PACK
	T70-0354	SIDE HUNG-12" OUTWARD OPENING SHEARS (EASY CLEAN)	T70-DPM-EC-12	SET
	T70-0355	SIDE HUNG-16" OUTWARD OPENING SHEARS (EASY CLEAN)	T70-DPM-EC-16	SET
	T70-0356	TOP HUNG-12" OUTWARD OPENING SHEARS	T70-DPM-12	SET
	T70-0357	TOP HUNG-16" OUTWARD OPENING SHEARS	T70-DPM-16	SET
	T70-0358	TOP HUNG-24" OUTWARD OPENING SHEARS	T70-DPM-24	SET
	T70-0359	ESPAGNOLETTE STRIKER (OUTSIDE OPENING SYSTEM)	T70-STR-70	Unit
	T70-0360	SLIM WINDOW HANDLE WITH KEY, EYE DROP MODEL - HANDLE OPENING ON THE LEFT (BLACK)	T70-GD-70	Unit
	T70-0361	SLIM WINDOW HANDLE WITH KEY, EYE DROP MODEL - HANDLE OPENING ON THE RIGHT (BLACK)	T70-GD-71	Unit
	T70-0504	MOUNTING FRAME FOR ALUMINIUM FRAME	T70-DMA.18	1 un / 1 pk

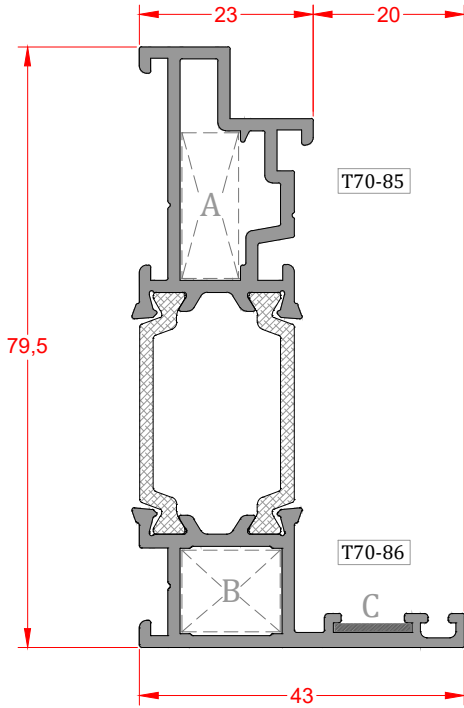

Frame Profile	Profile Code	Weight	Jx cm ⁴	Jy cm ⁴
		T70-85-86	1,269	39,02
	A	B	C	
	KT-2046-1930	KT-2371-1080	KG.100	
	2046-026	2371-008	AKS4153	

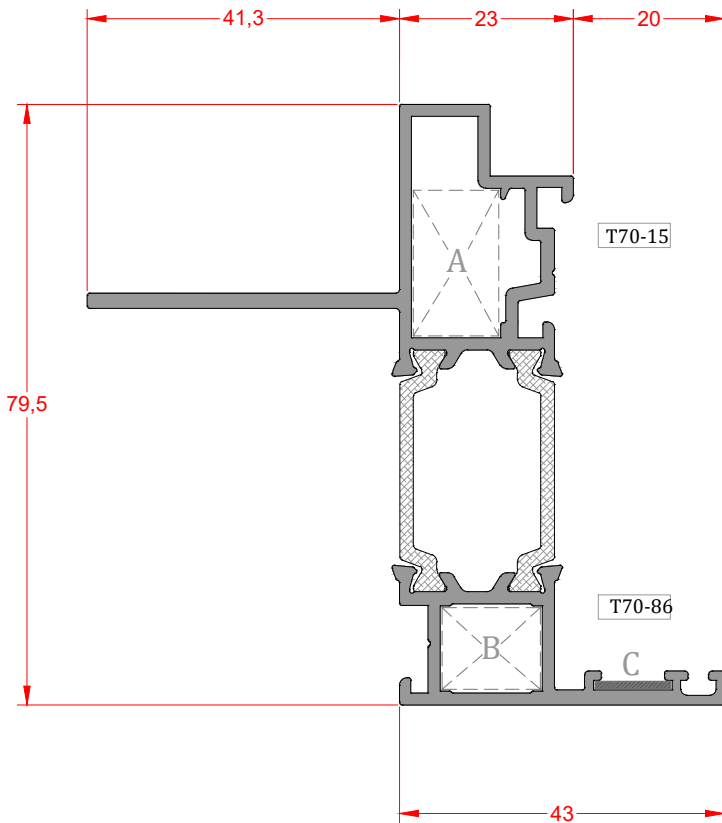

Frame Profile	Profile Code	Weight	Jx cm ⁴	Jy cm ⁴
		T70-15-86	1,479	39,01
	A	B	C	
	KT-5022-1930	KT-2371-1080	KG.100	
	5022-057	2371-008	AKS4153	

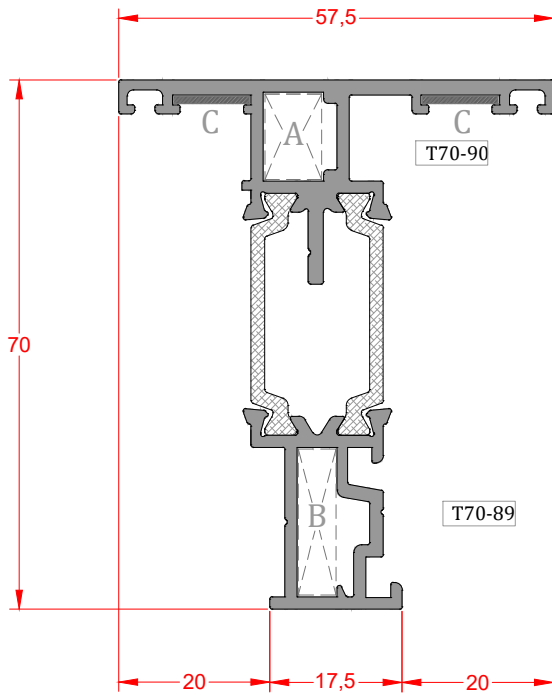

Sash Profile	Profile Code	Weight	Jx cm ⁴	Jy cm ⁴
		T70-90-89	1,293	27,94
	A	B	C	
	KT-2046-1130	KT-2045-1930	KG.100	
	2046-027	2045-009	AKS4153	

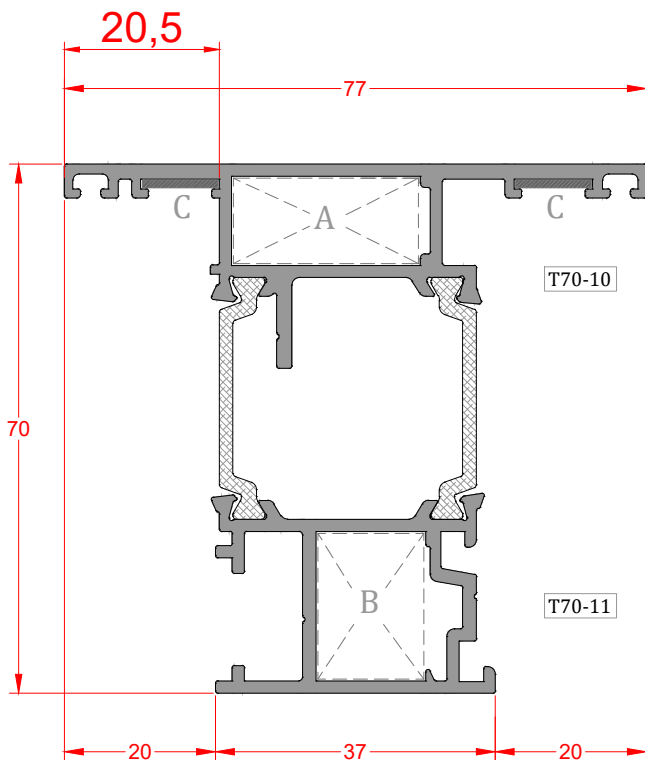

Sash Profile	Profile Code	Weight	Jx cm ⁴	Jy cm ⁴
		T70-10-11	1,675	38,81
	A	B	C	
	KT-14773-1130	KT-1662-1930	KG.100	
	14773-003	1662-105	AKS4153	

TGP SLIM CASEMENT PROFILE

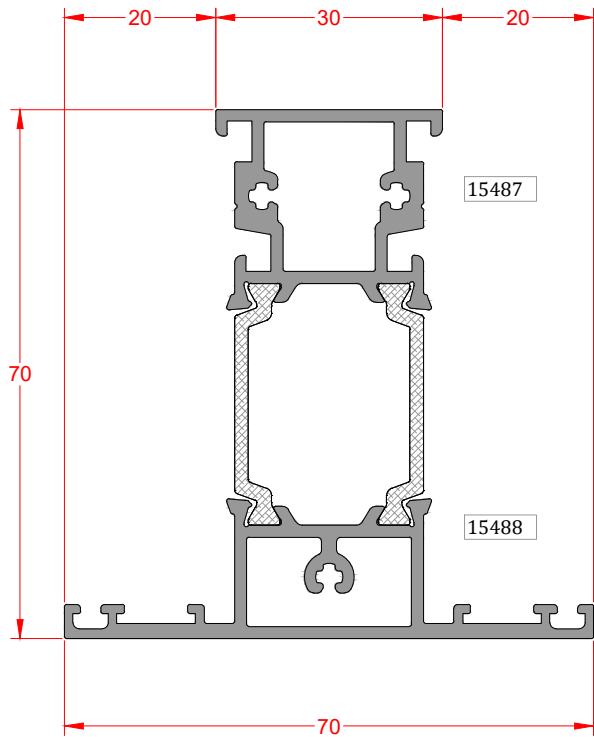

Mullion Profile	Profile Code	Weight	Jx cm ⁴	Jy cm ⁴
	70-15487-15488	1,585	39,82	11,54

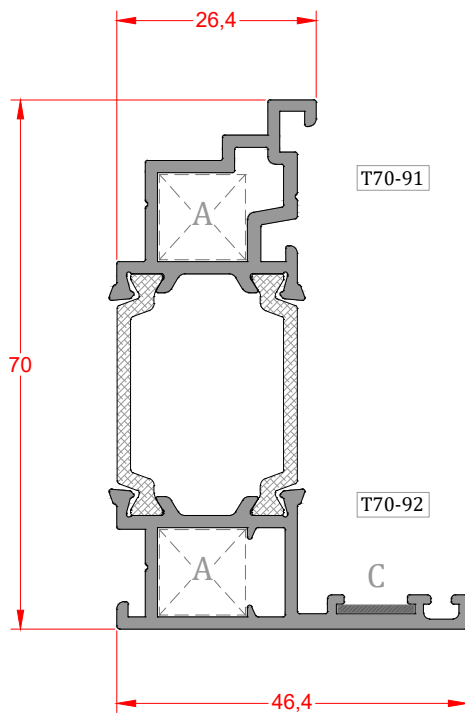

Adapter Profile	Profile Code	Weight	Jx cm ⁴	Jy cm ⁴
	T70-91-92	1,195	25,11	5,98

A	C
KT-5022-1130	KG.100
5022-058	AKS4153

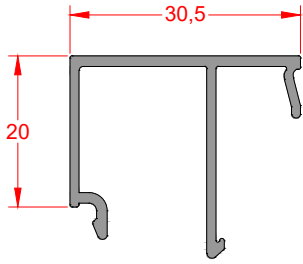

Glazing Bead	Profile Code	Weight
	T70-93	0,316

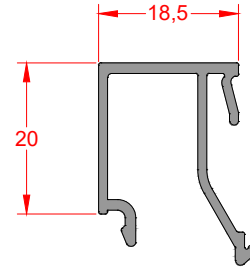

Cam Çıtası GLAZING BEAD	Profile Code	Weight
	T70-14	0,277

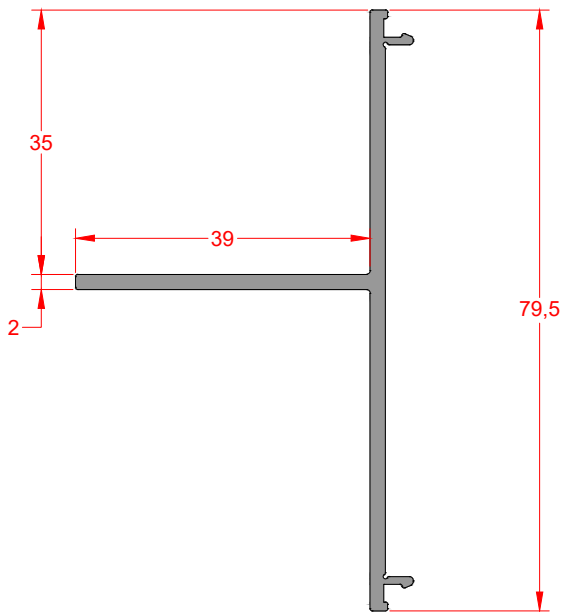

Nail fin Profile	Profile Code	Weight
	T70-12	0,662

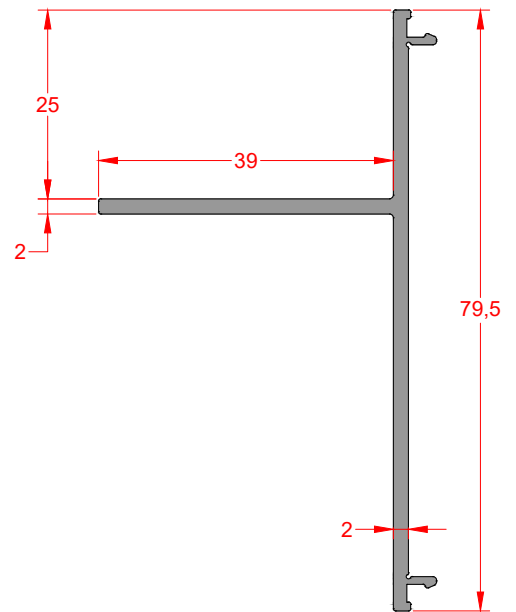

Nail fin Profile	Profile Code	Weight
	T70-13	0,662

TSC 70

Fluschcase Opening Window
Details (Casement)

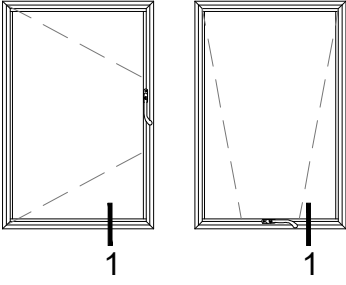

İÇ
(INSIDE)

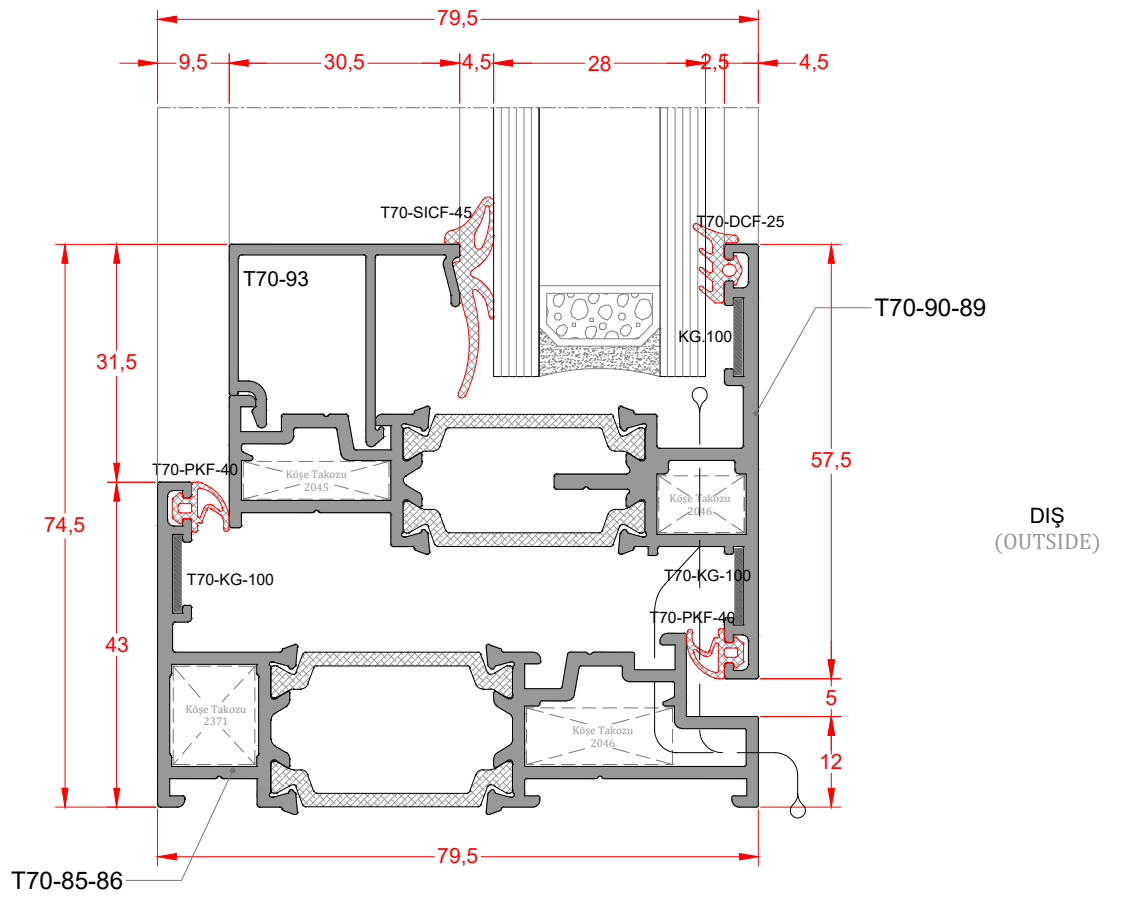

DIŞ
(OUTSIDE)

D-1

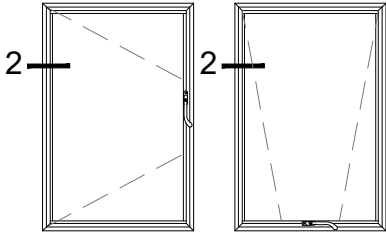

İÇ
(INSIDE)

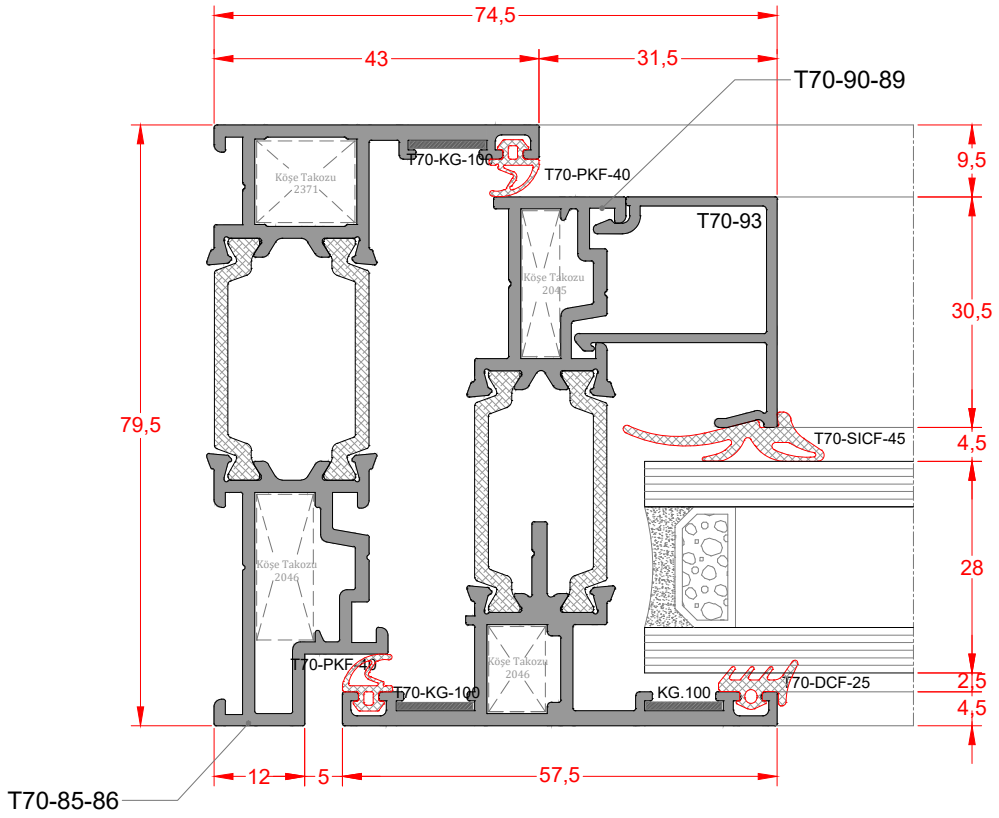

DIŞ
(OUTSIDE)

D-2

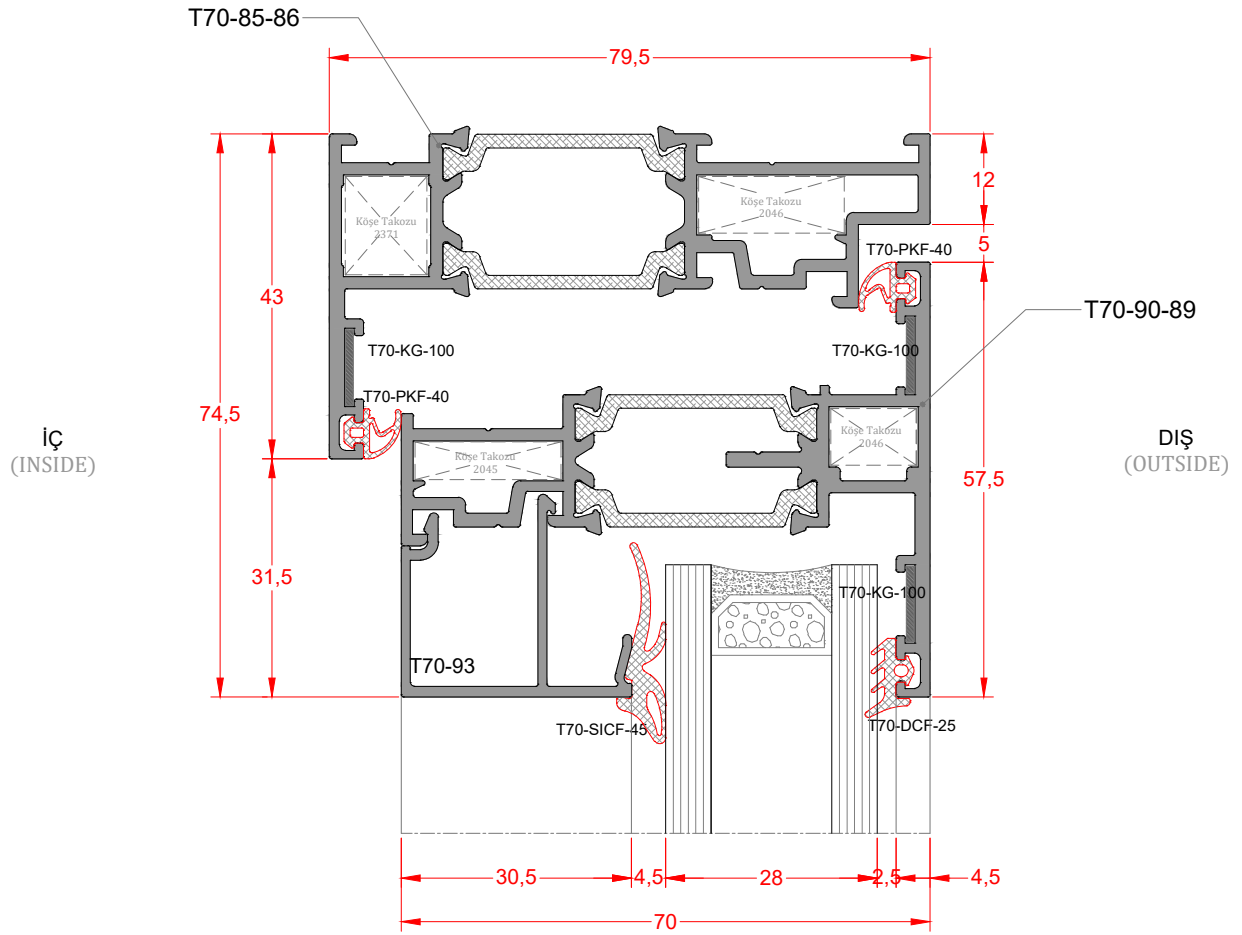
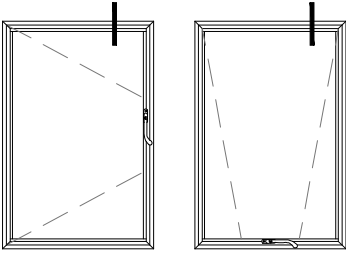

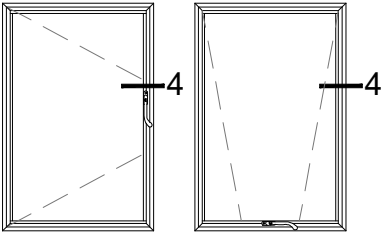

İÇ
(INSIDE)

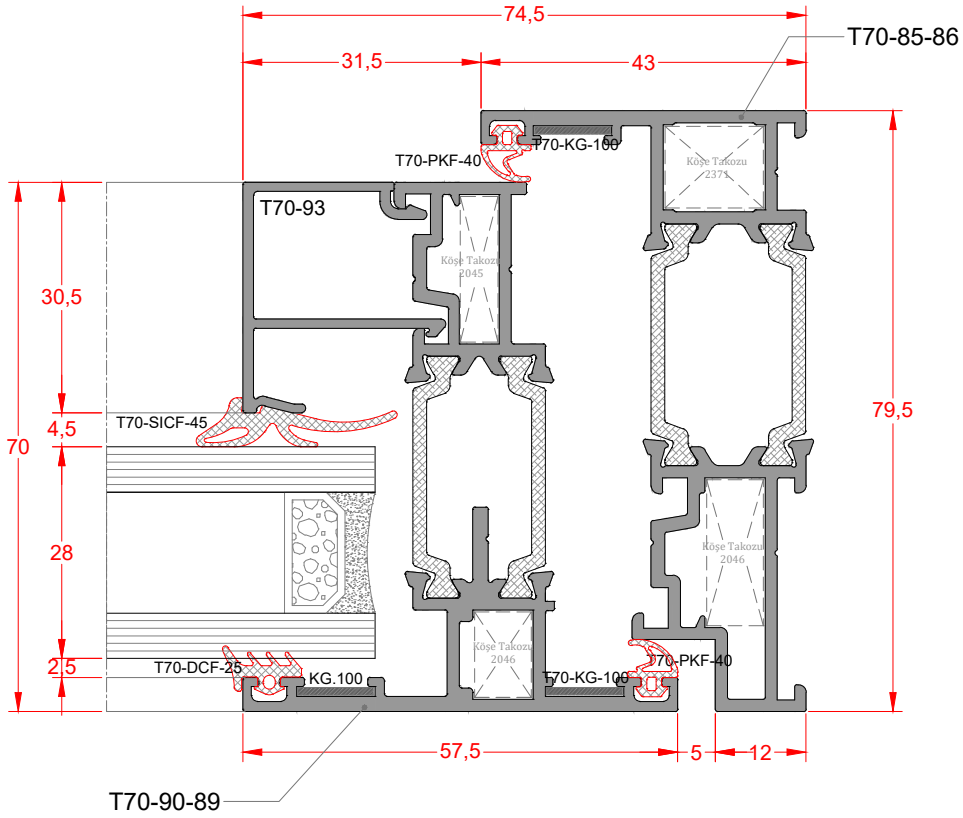

DIŞ
(OUTSIDE)

D-4

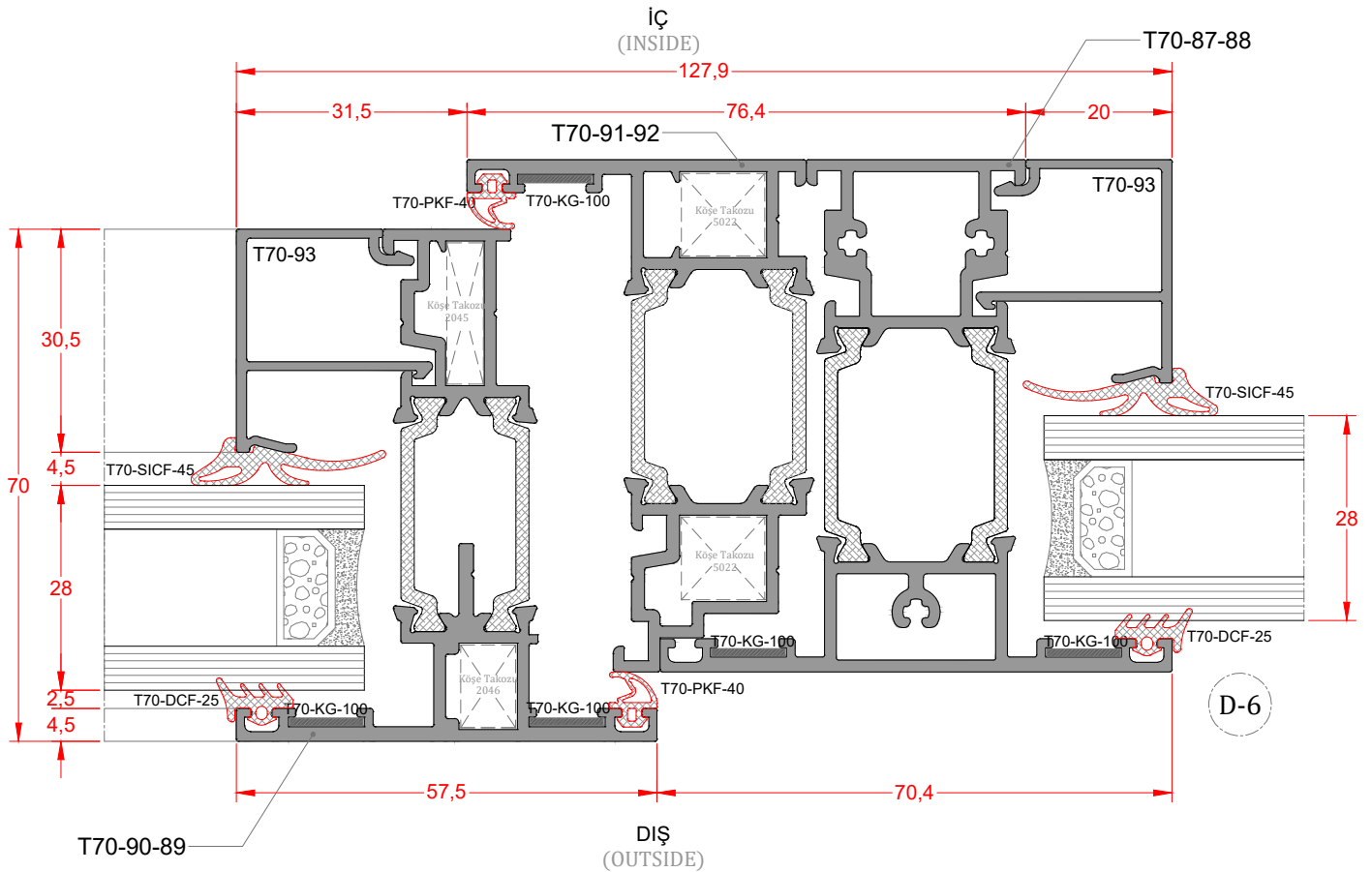
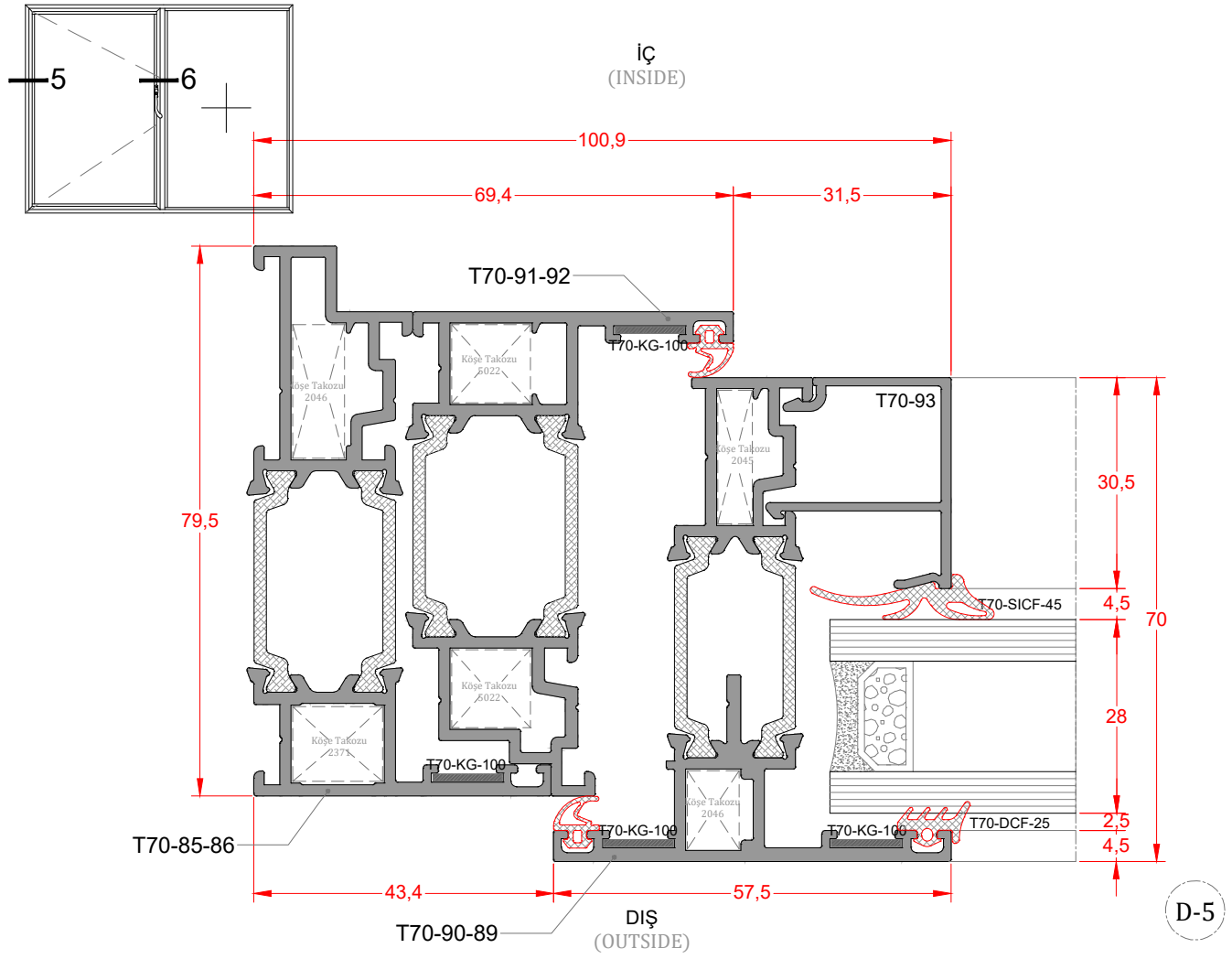

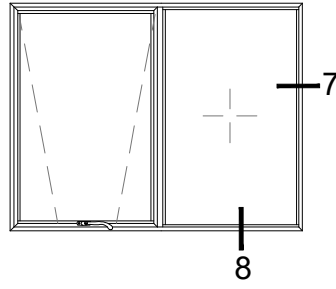
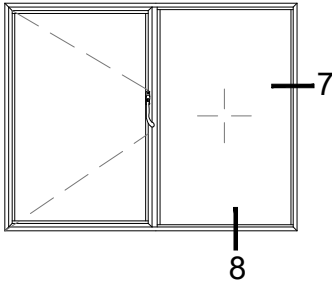

iç
(INSIDE)

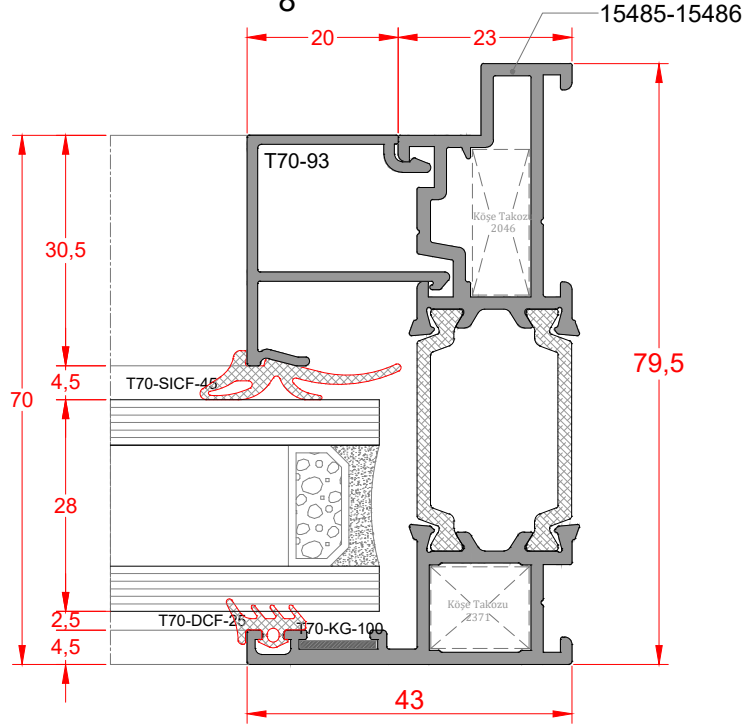

DIŞ
(OUTSIDE)

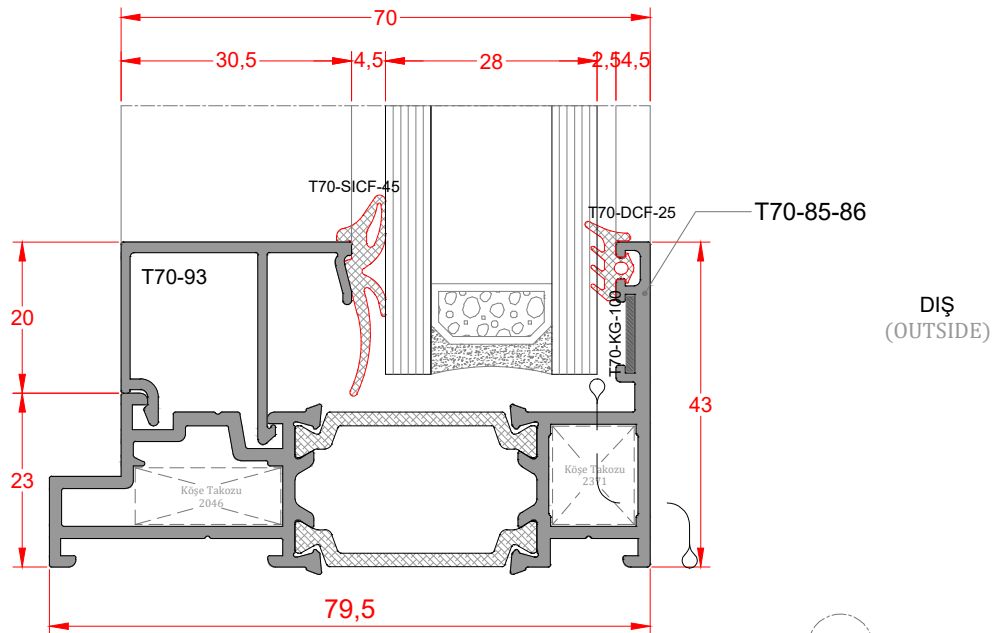

iç
(INSIDE)

DIŞ
(OUTSIDE)

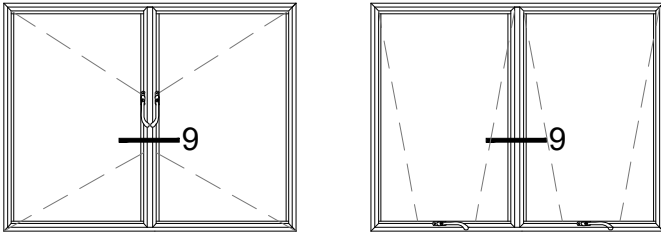

İÇ
(INSIDE)

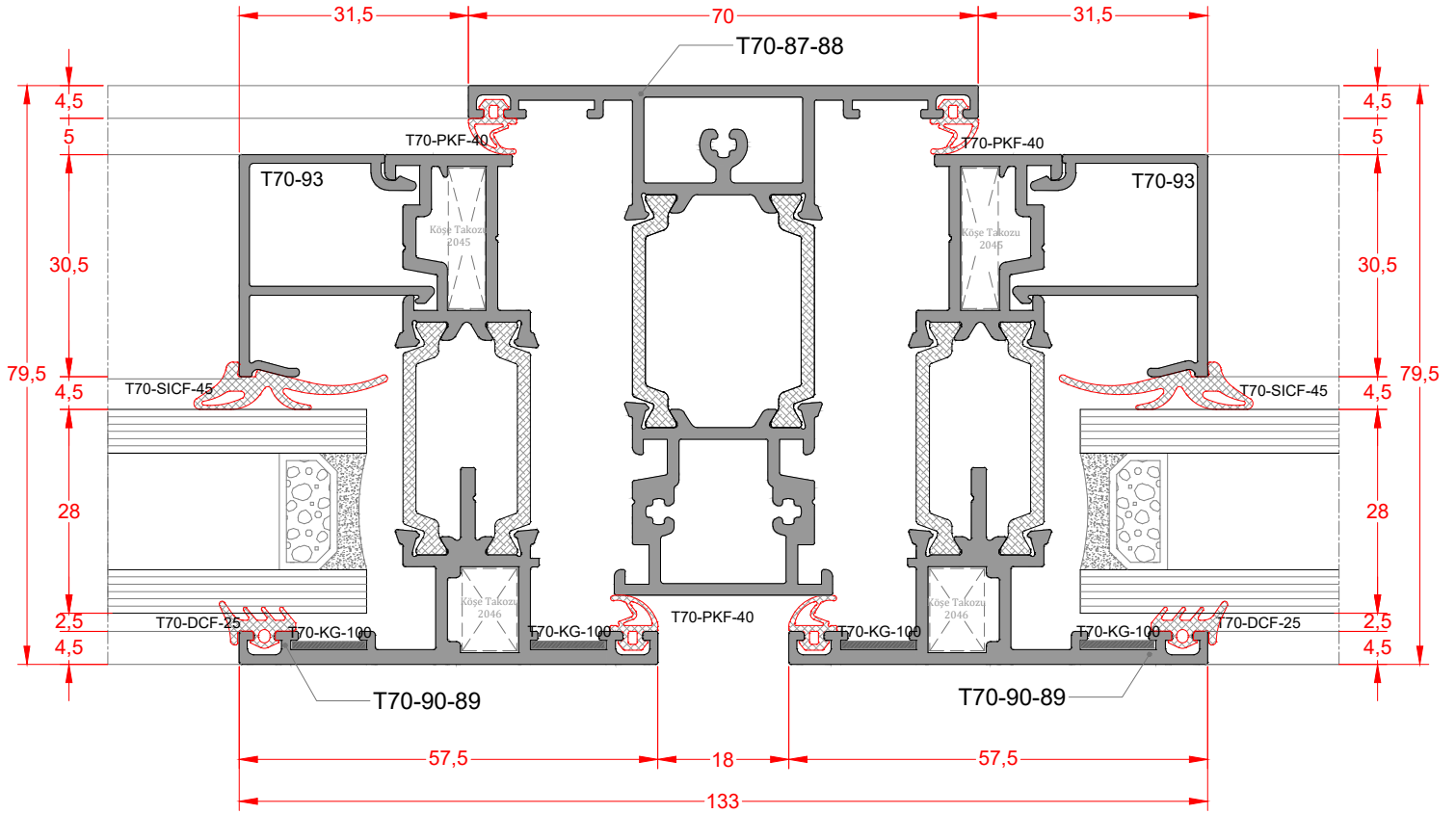

DIŞ
(OUTSIDE)

D-9

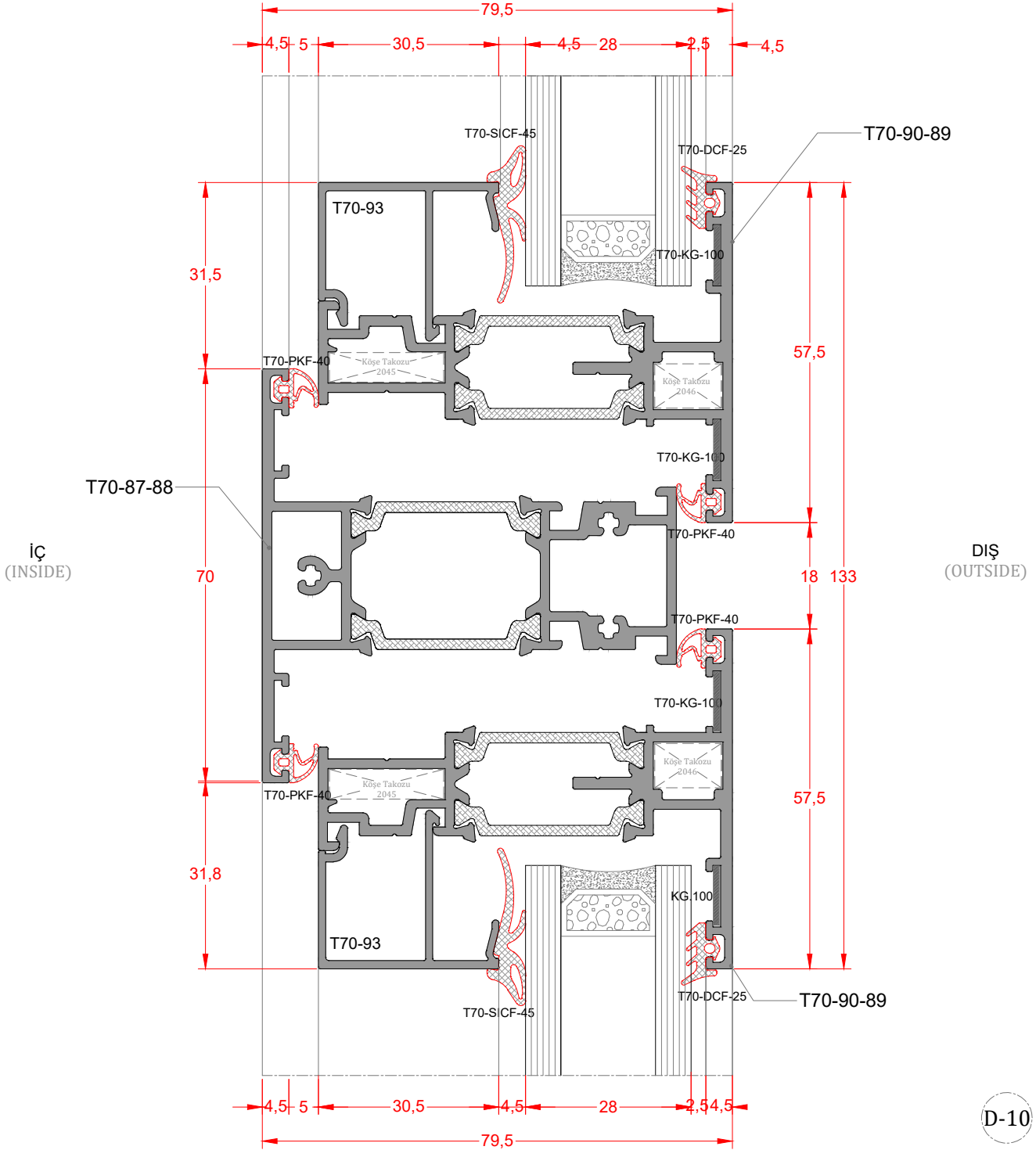
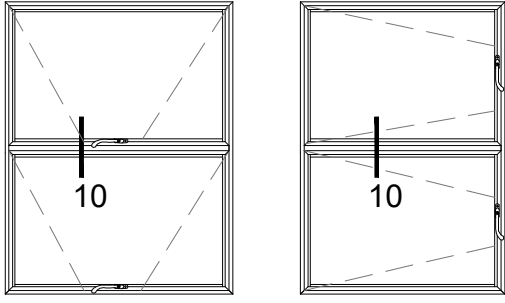

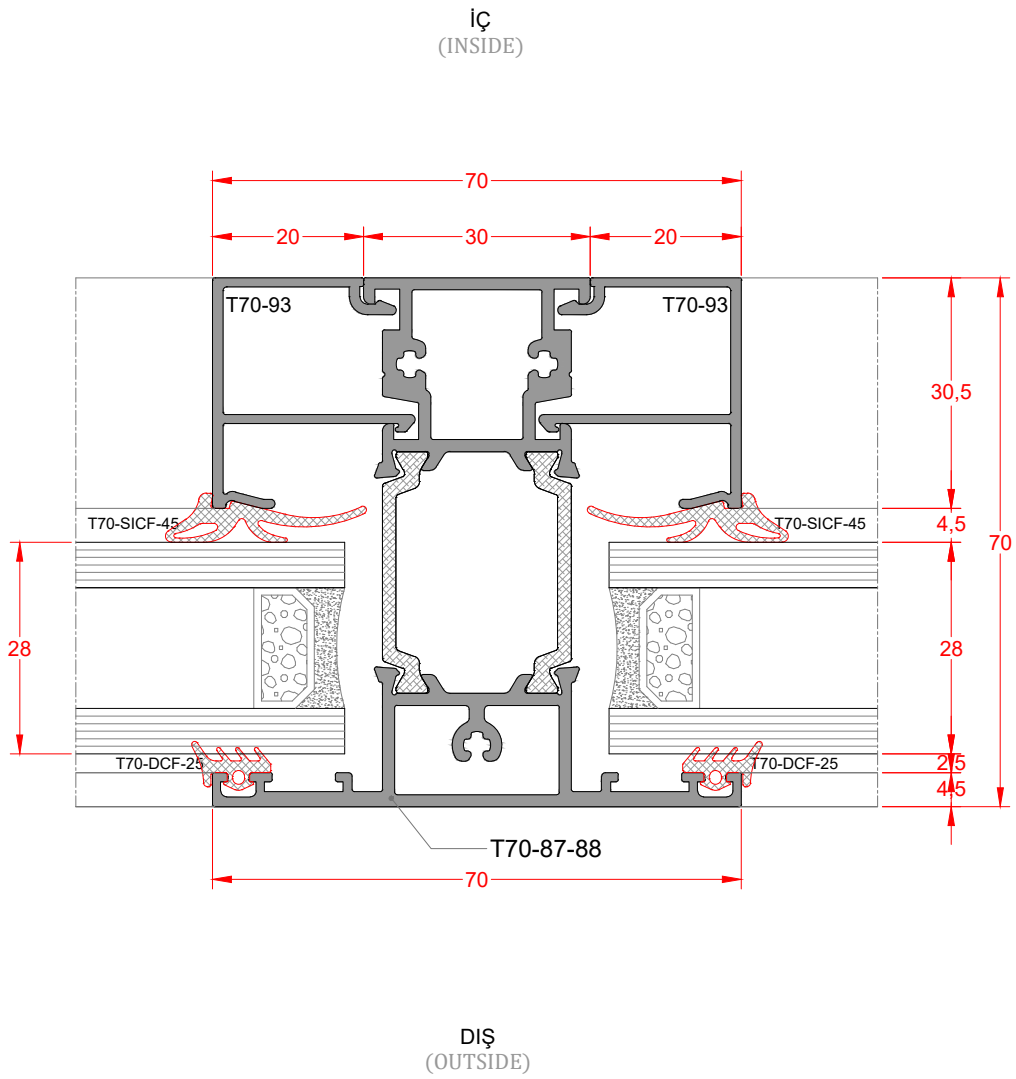
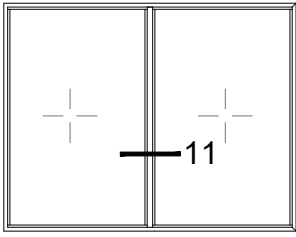

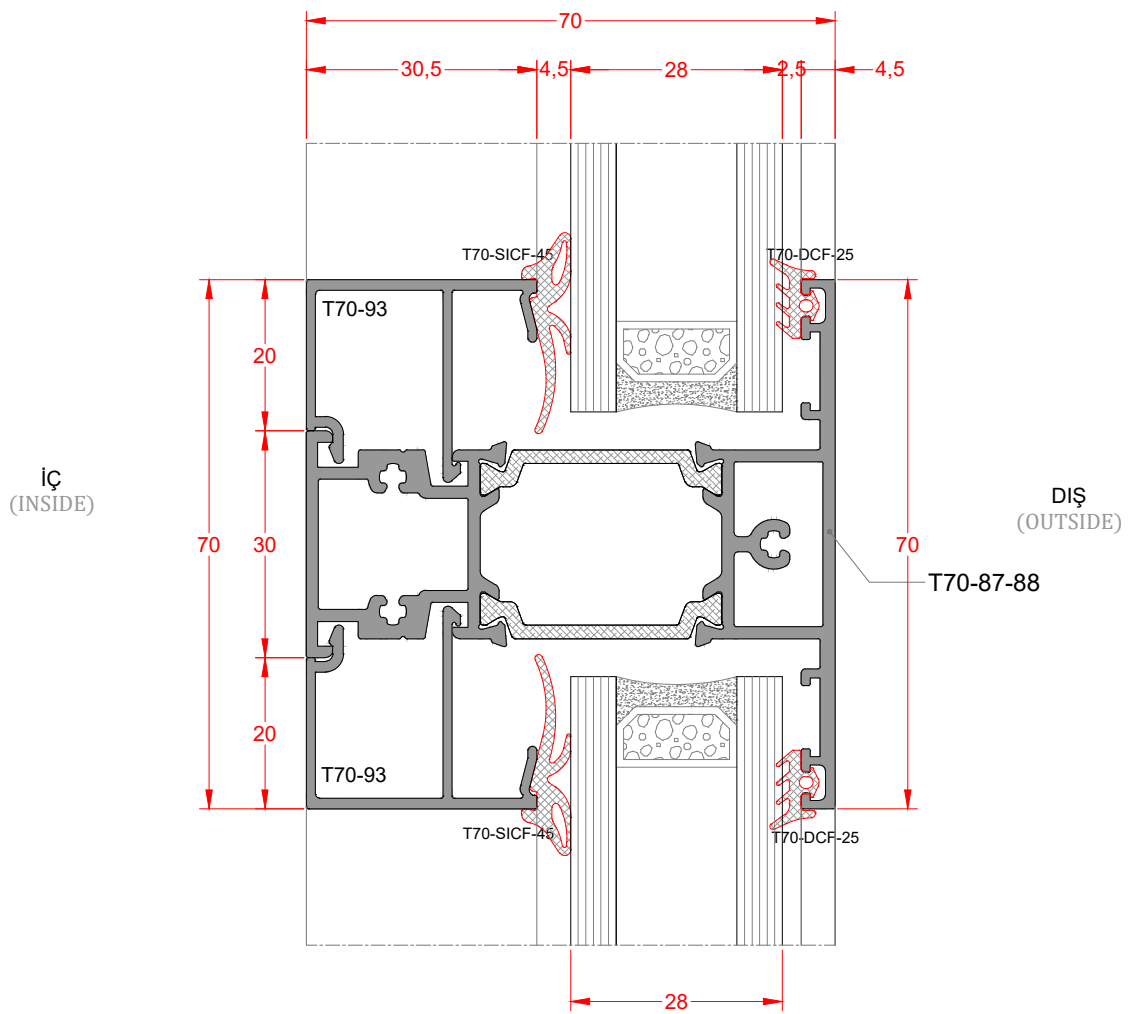
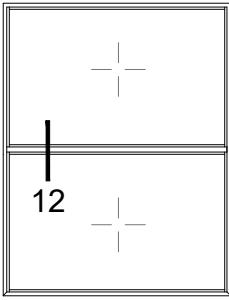

TSC 70

Fluschcase Nail Fin Opening
Window Details (Casement)

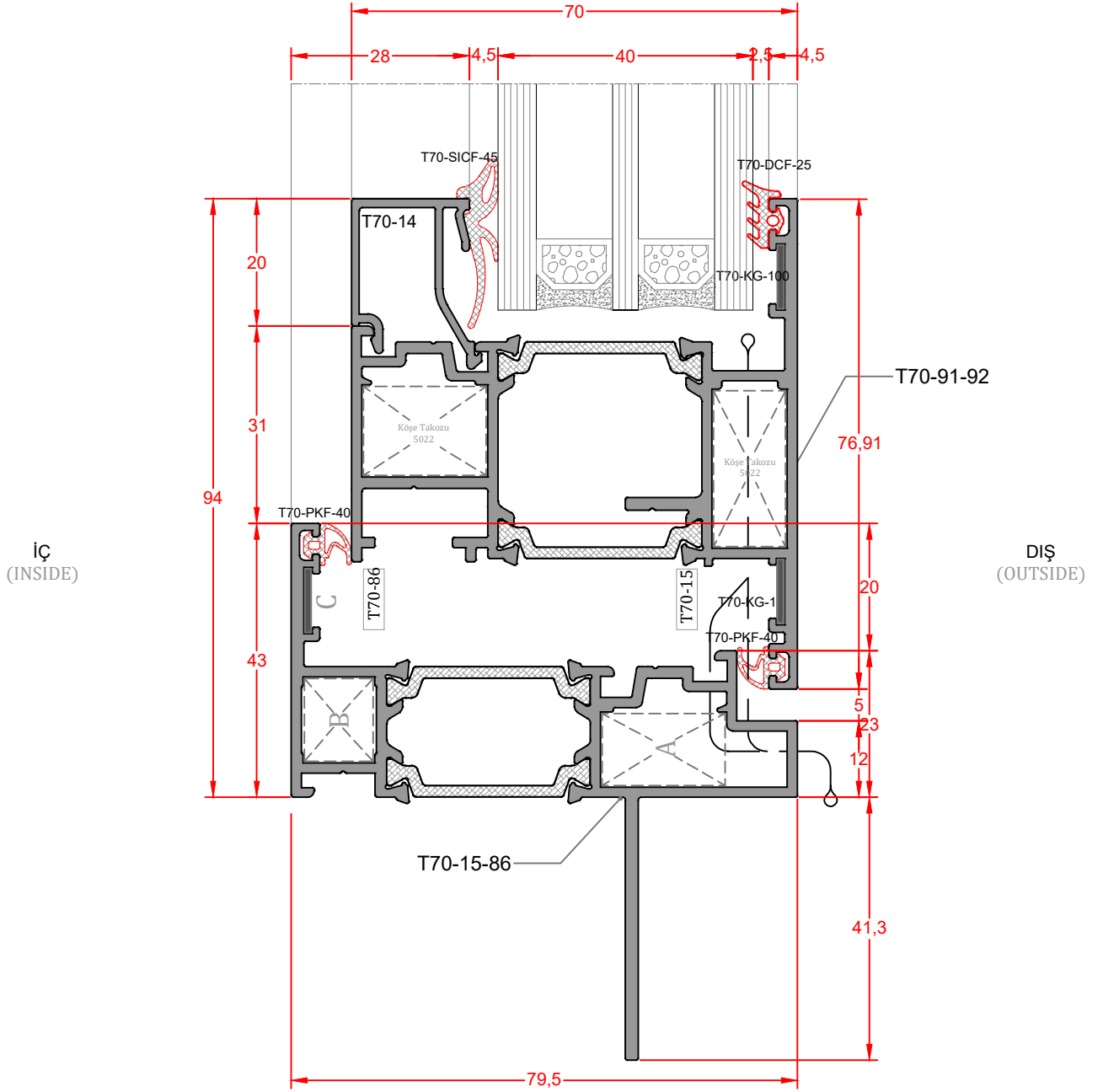
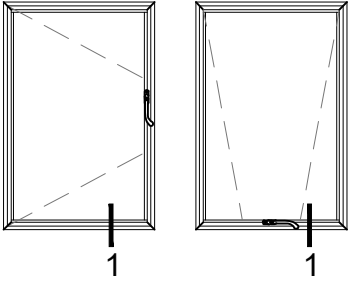

D-1

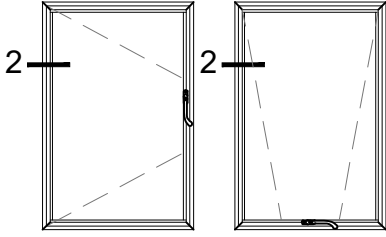

İÇ
(INSIDE)

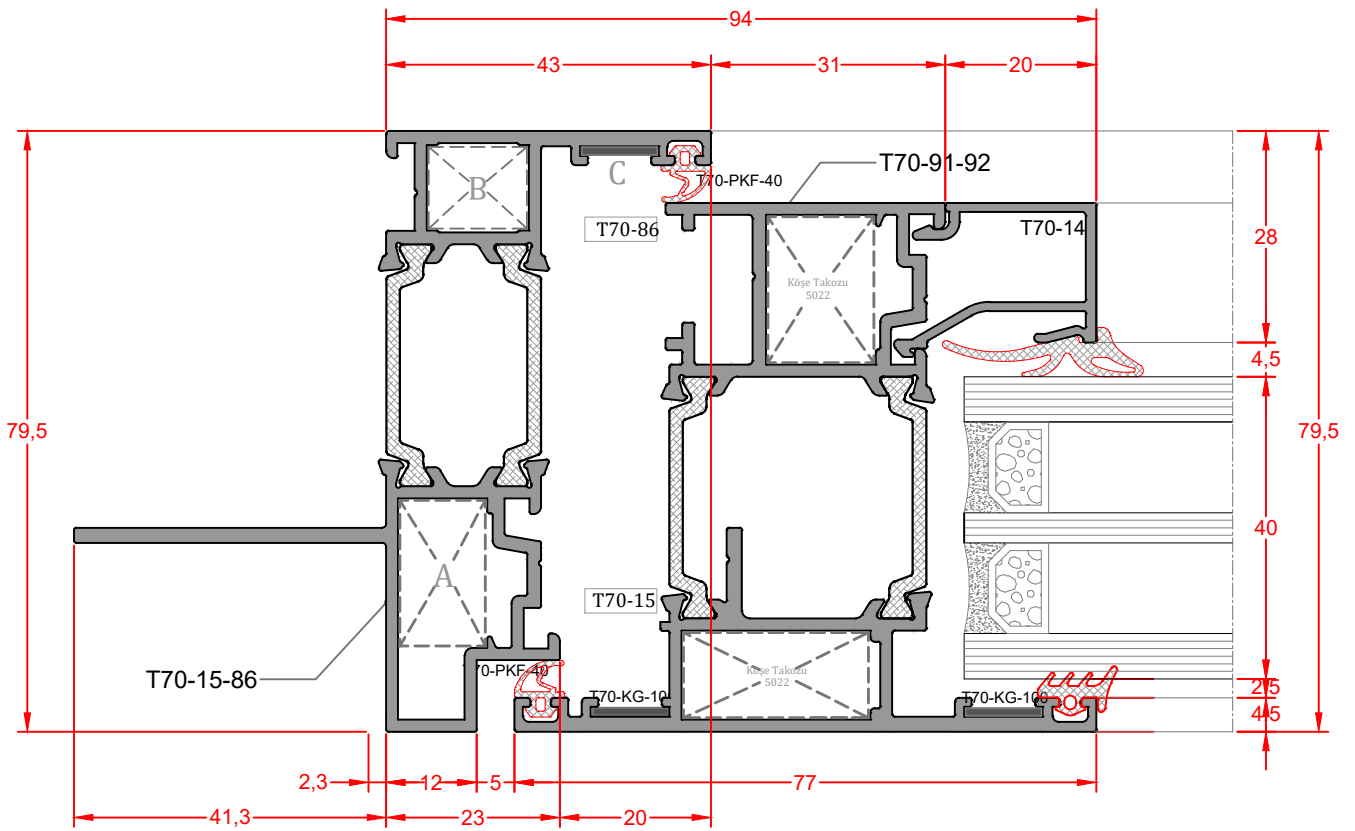

DIŞ
(OUTSIDE)

D-2

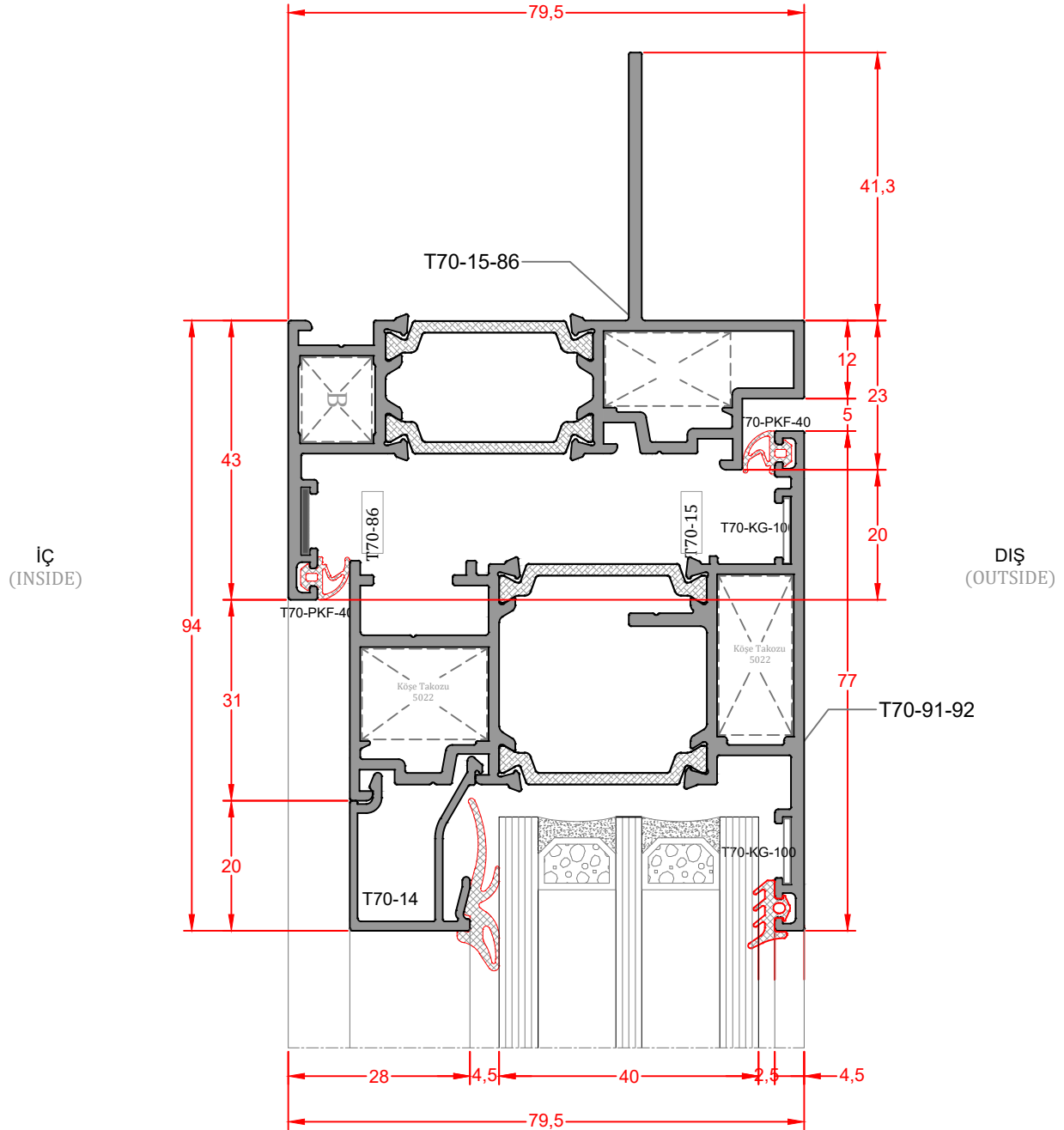
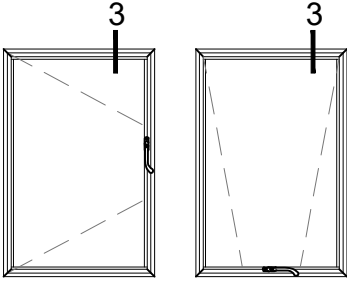

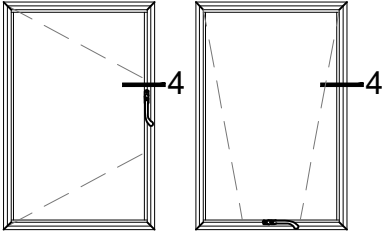

İÇ
(INSIDE)

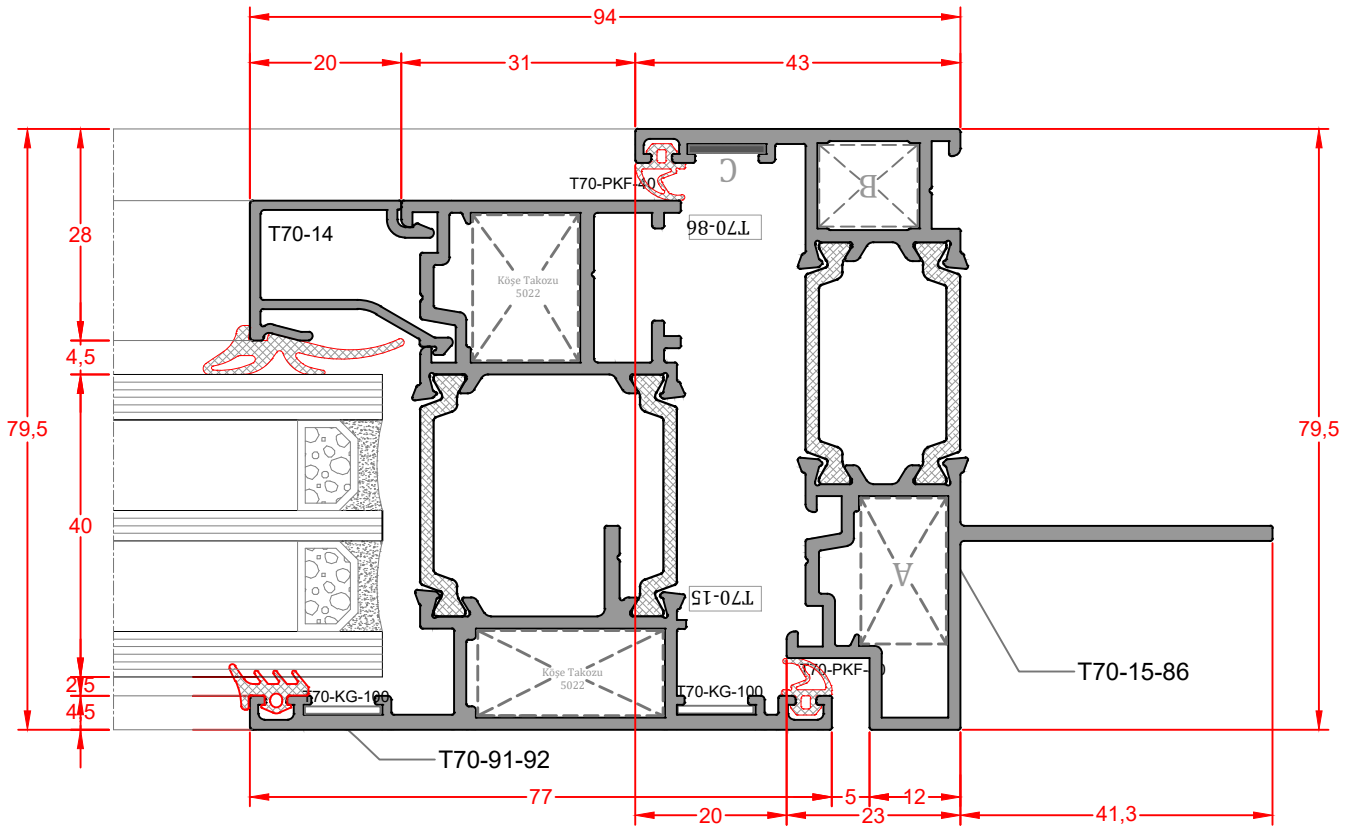

DIŞ
(OUTSIDE)

D-4