

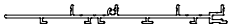







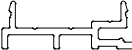
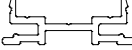
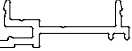
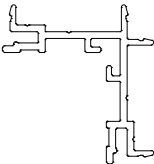

# DECOAL SERIES

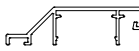
ALUMINIUM FACADE CLADDING  
SYSTEM

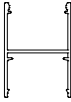
PROFILE SECTION	PROFILE CODE	PROFILE NAME	Jx cm <sup>4</sup>	Jy cm <sup>4</sup>	WEIGHT(kg/m)
	E-DA-217-0*	3 PROFILE - BODY	-	-	1,504 kg/m
	E-DA-147-0*	2 PROFILE - BODY	-	-	1,032 kg/m
	E-DA-42-0*	ENDING PROFILE	-	-	0,203 kg/m
	E-DA-33S-0*	STARTED PROFILE	-	-	0,313 kg/m
	E-DA-30-0*	TRANSITION PROFILE	-	-	0,343 kg/m
	E-DA-33-0*	TRANSITION PROFILE	-	-	0,294 kg/m
	E-DA-33C-0*	90° CORNER PROFILE	-	-	0,599 kg/m
	E-DA-35-0*	FINISH PROFILE (4 mm)	-	-	0,301 kg/m
	E-DA-75-0*	DA75 PROFILE	-	-	0,694 kg/m
	E-DA-105-0*	DA105 PROFILE	-	-	0,767 kg/m
	E-DA-35L-0*	DA35L PROFILE (LED APPLICATION)	-	-	0,583 kg/m
	E-DA-30L-0*	DA30L COVER PROFILE	-	-	0,122 kg/m
	E-DA-35-L*	DA35-LONG PROFILE	-	-	0,686 kg/m
	E-DA-35-0*	DA35-SMALL PROFILE	-	-	0,311 kg/m
	E-DA-30-0-0	ADD-ON PROFILE	-	-	-

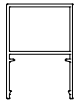

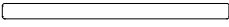
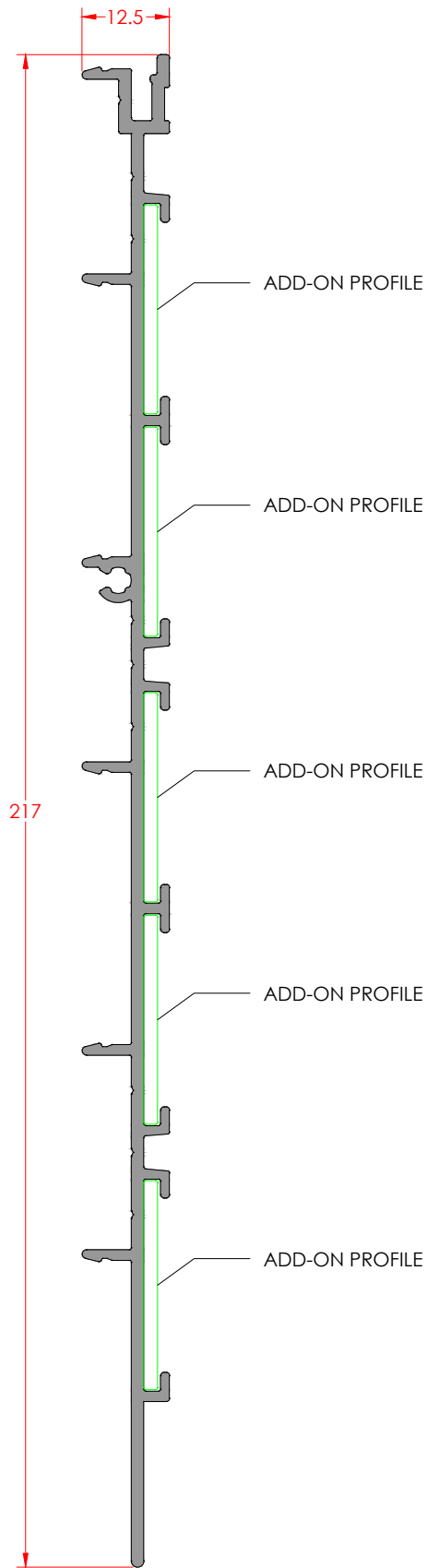

3 PROFILE - BODY  
Profile Code: E-DA-217-0-  
Weight/mt: 1,504

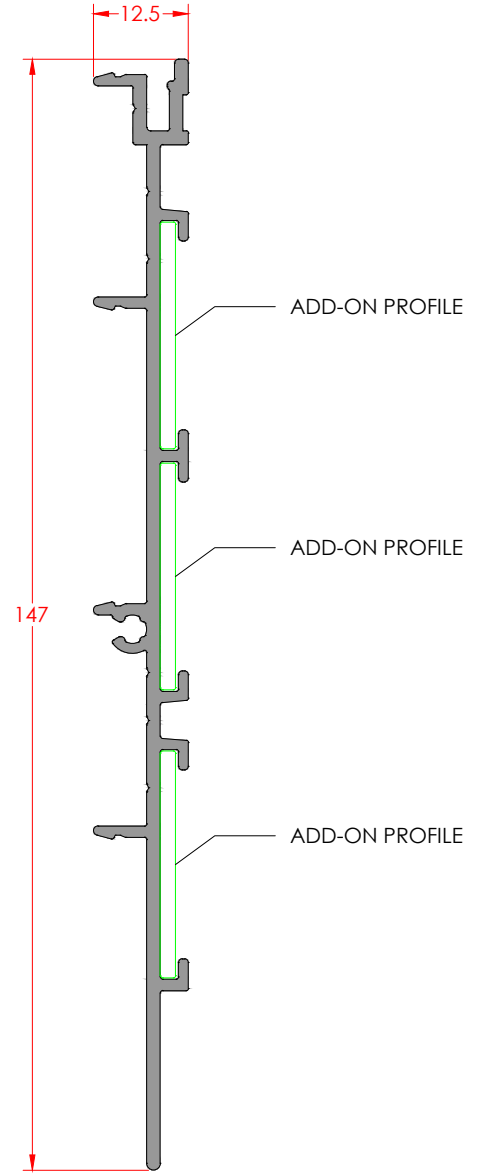

2 PROFILE - BODY  
Profile Code: E-DA-147-0-  
Weight/mt: 1,032

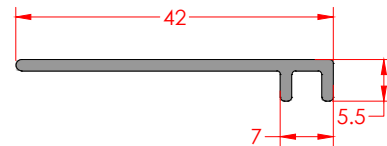

ENDING PROFILE  
Profile Code: E-DA-42-0-  
Weight/mt: 0,203

\* The selected color must be specified.

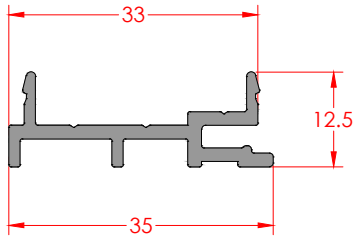

**STARTED PROFILE**  
 Profile Code: E-DA-33S-0-  
 Weight/mt: 0,313

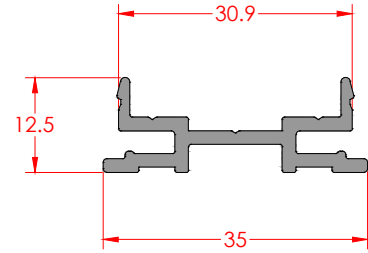

**TRANSITION PROFILE**  
 Profile Code: E-DA-30-0-  
 Weight/mt: 0,343

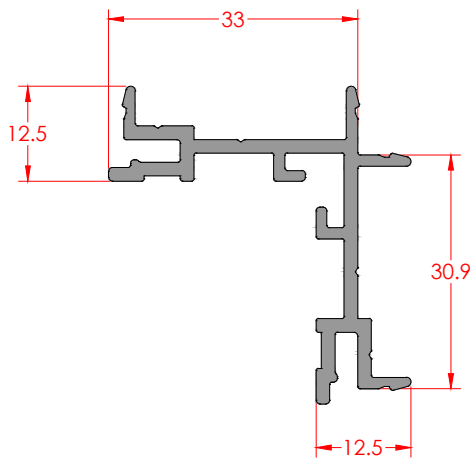

**90° CORNER PROFILE**  
 Profile Code: E-DA-33C-0-  
 Weight/mt: 0,599

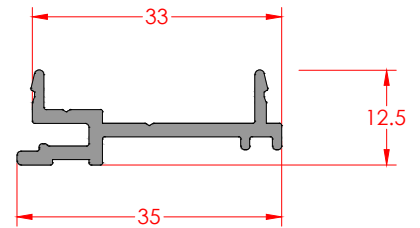

**TRANSITION PROFILE**  
 Profile Code: E-DA-33-0-  
 Weight/mt: 0,294

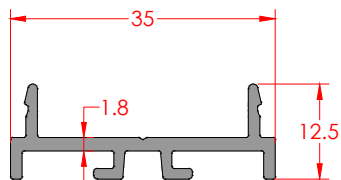

**FINISHED PROFILE (4 mm)**  
 Profile Code: E-DA-35-0-  
 Weight/mt: 0,301

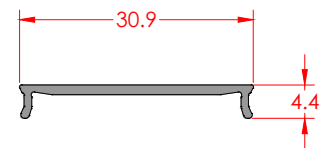

**LED COVER PROFILE**  
 Profile Code: E-DA-30L-0-  
 Weight/mt: 0,122

\* The selected color must be specified.

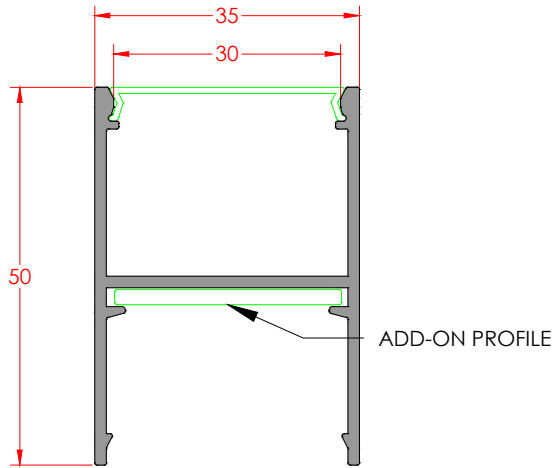

DA35L PROFILE (LED APPLICATION)  
Profile Code: E-DA-35L-0-  
Weight/mt: 0,583

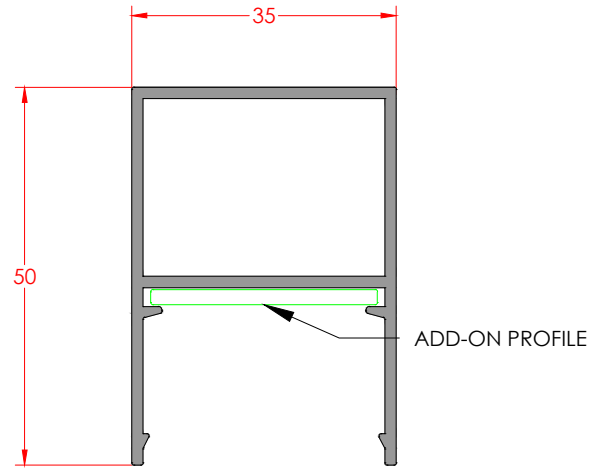

DA35-LONG PROFILE  
Profile Code: E-DA-352-0-  
Weight/mt: 0,686

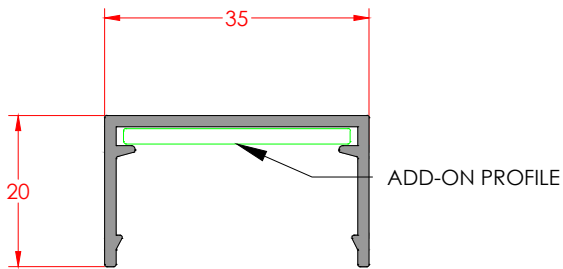

DA35-SMALL PROFILE  
Profile Code: E-DA-35-0-  
Weight/mt: 0,311

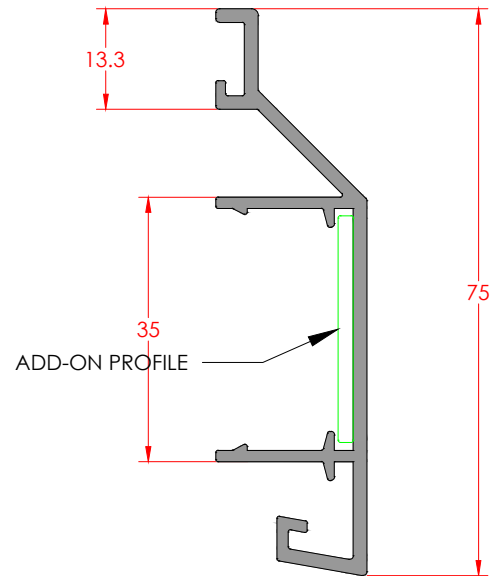

DA75 PROFILE  
Profile Code: E-DA-75-0-  
Weight/mt: 0,694

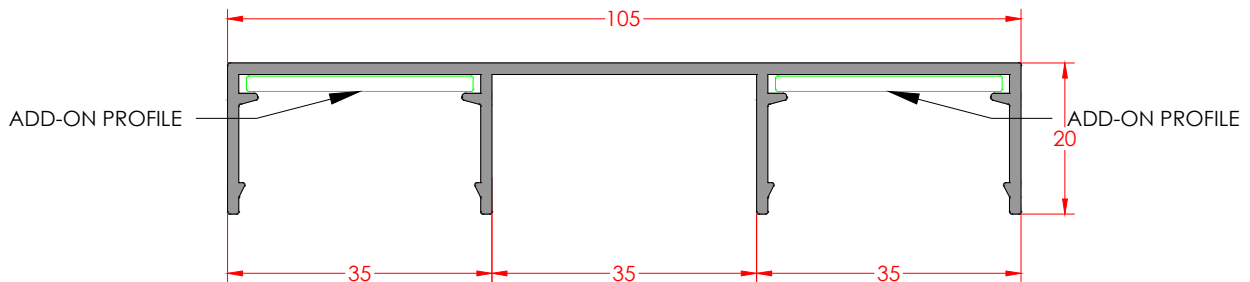

DA105 PROFILE  
Profile Code: E-DA-105-0-  
Weight/mt: 0,767

\* The selected color must be specified.

# DECOAL SERIES

35 COVERED FUNCTIONS

COVERED VERTICAL DETAIL

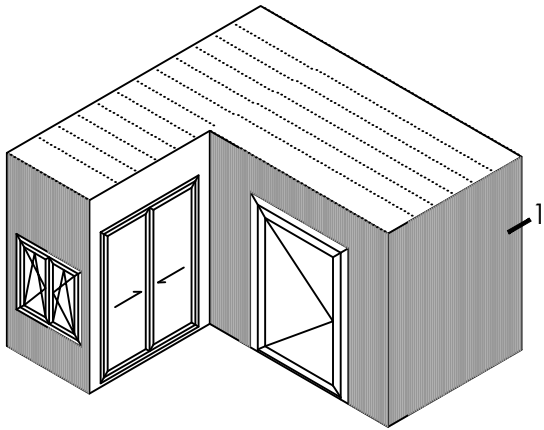

INSIDE

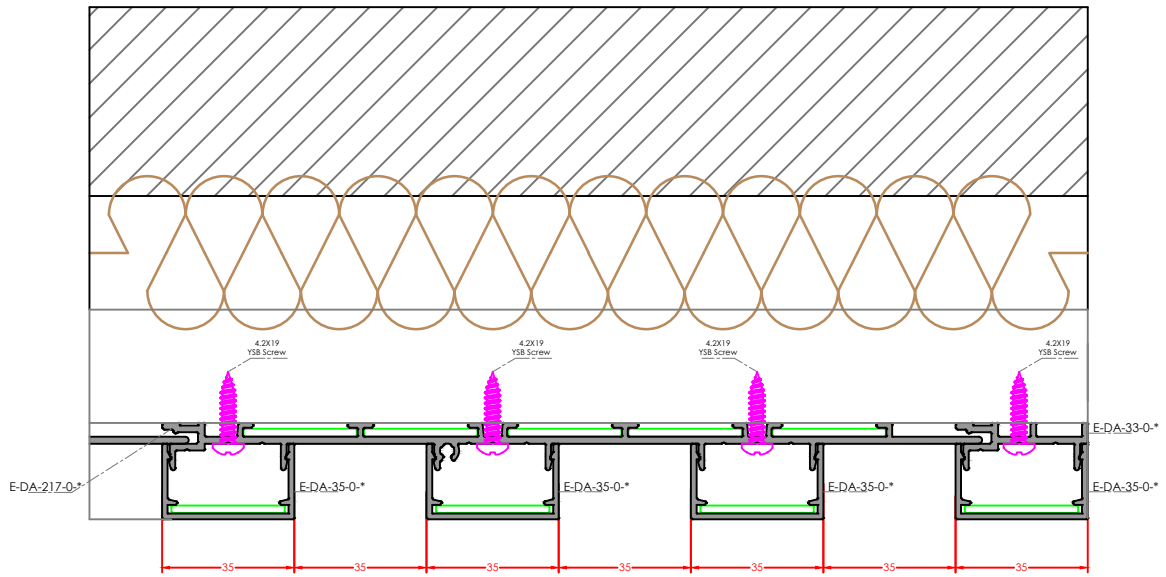

OUTSIDE

\* The selected color must be specified.

TRANSITIONAL COVERED VERTICAL DETAIL

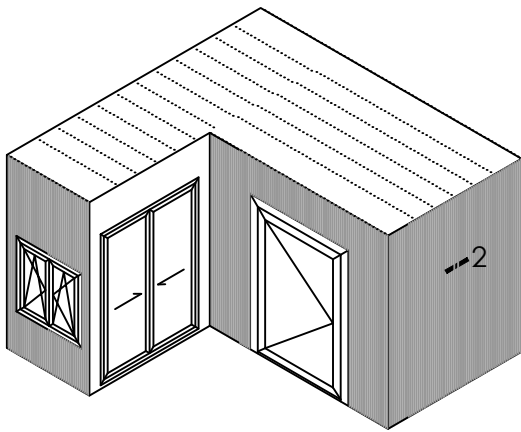

INSIDE

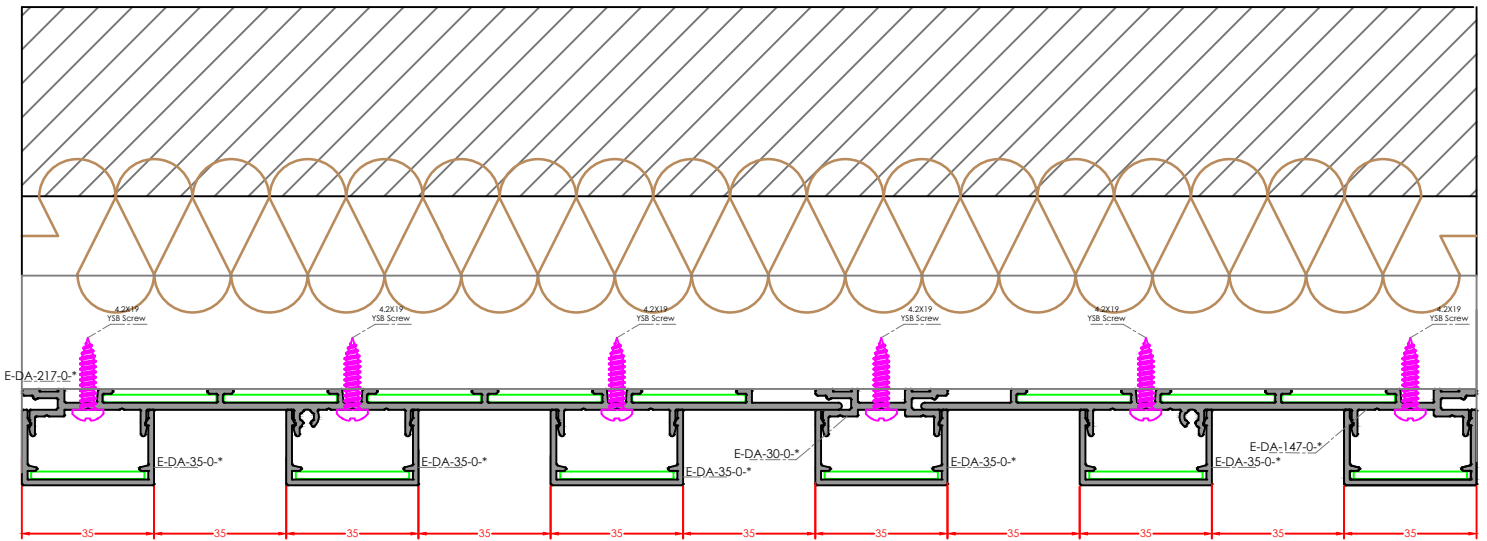

OUTSIDE

\* The selected color must be specified.

ALUMINIUM WINDOW SYSTEM TRANSITION VERTICAL DETAIL

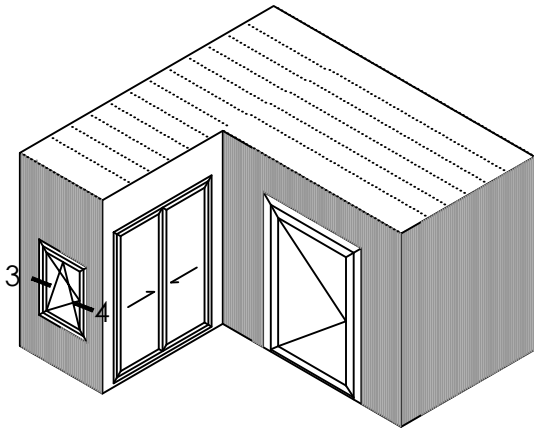

INSIDE

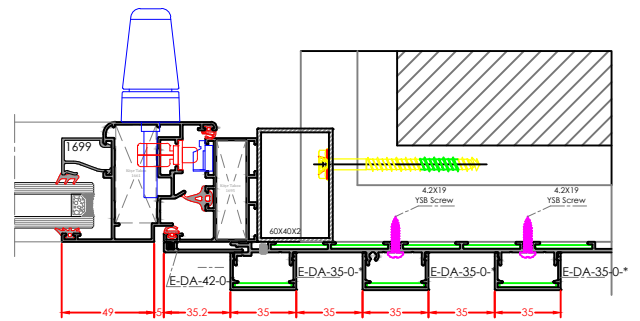
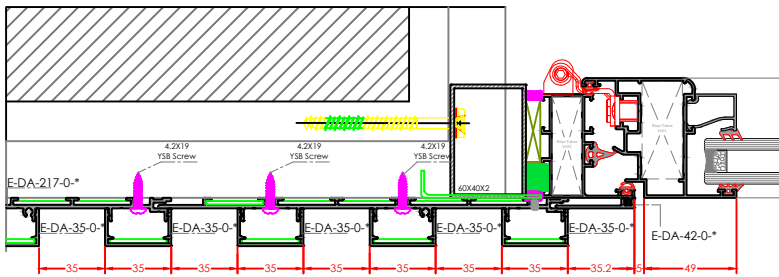

OUTSIDE

\* The selected color must be specified.



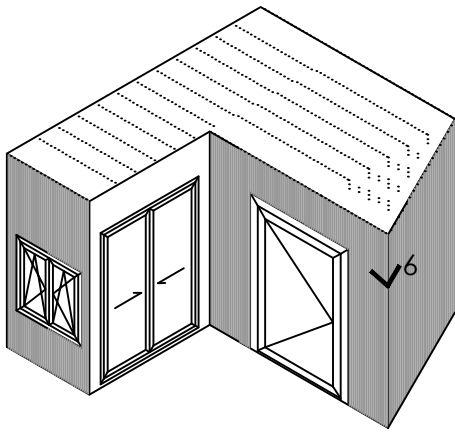

INSIDE

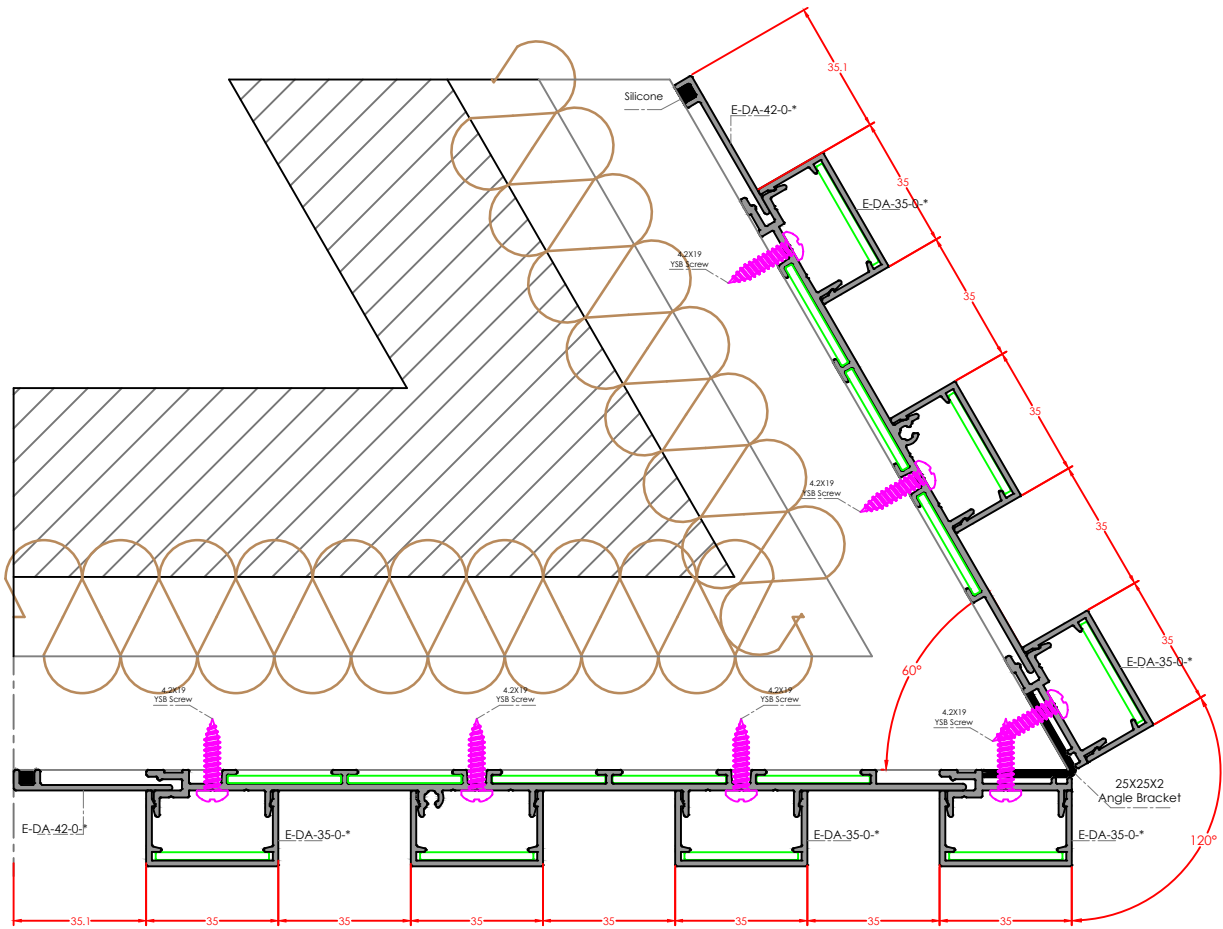

OUTSIDE

\* The selected color must be specified.

INWARD COVERED DETAIL

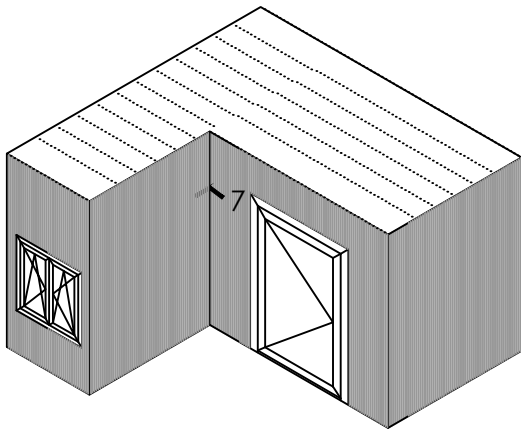

INSIDE

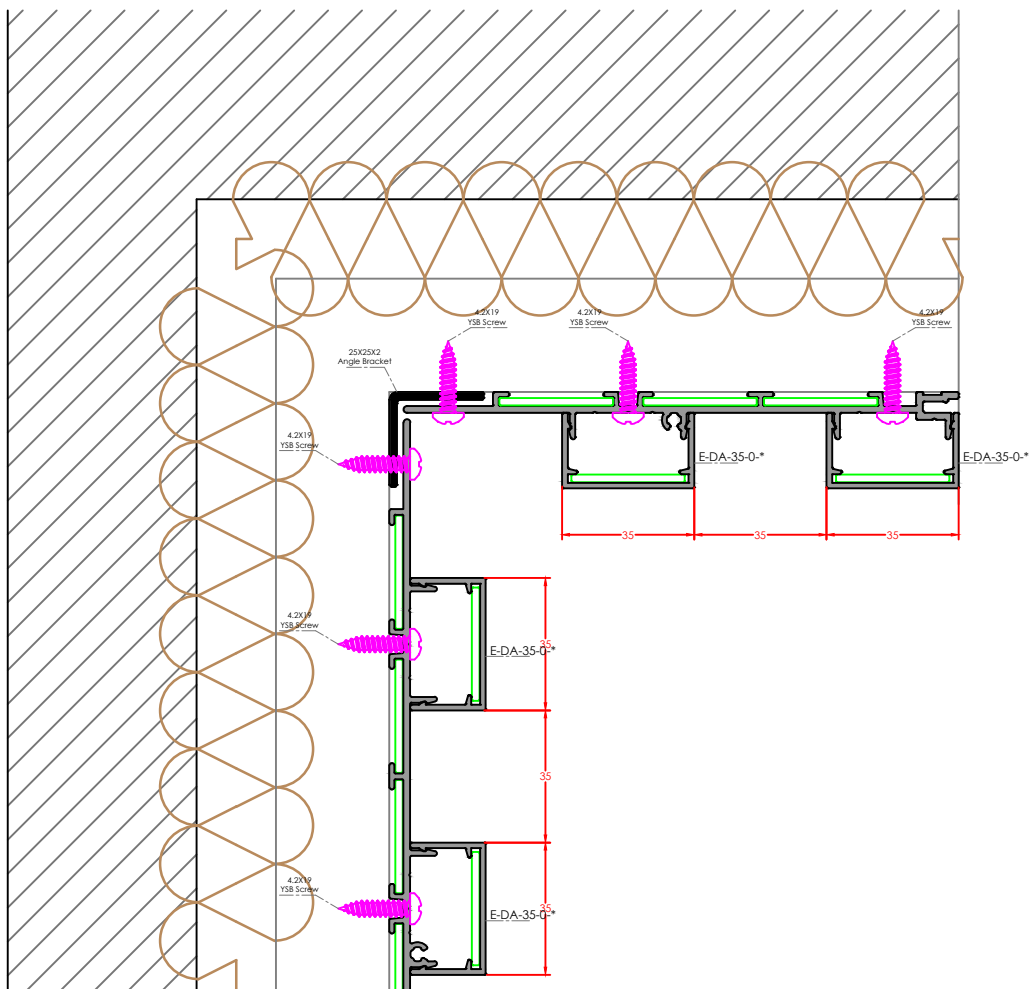

OUTSIDE

\* The selected color must be specified.



[www.tgpsystems.com](http://www.tgpsystems.com)

# DECOAL SERIES

35L COVERED FUNCTIONS

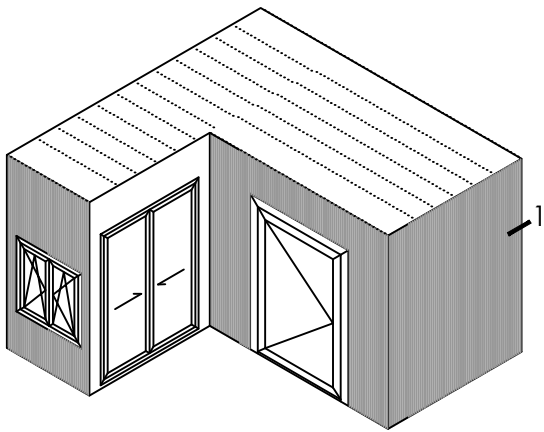

INSIDE

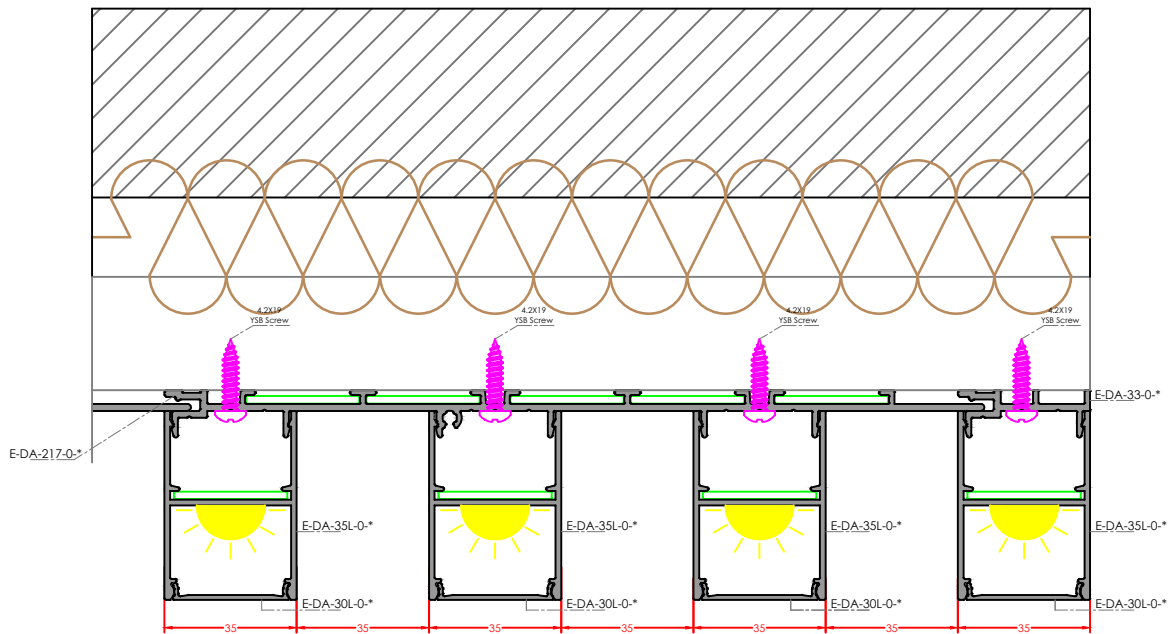

OUTSIDE

\* The selected color must be specified.

TRANSITIONAL COVERED VERTICAL DETAIL

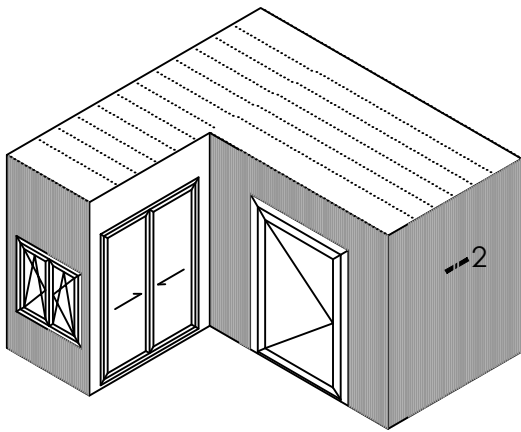

INSIDE

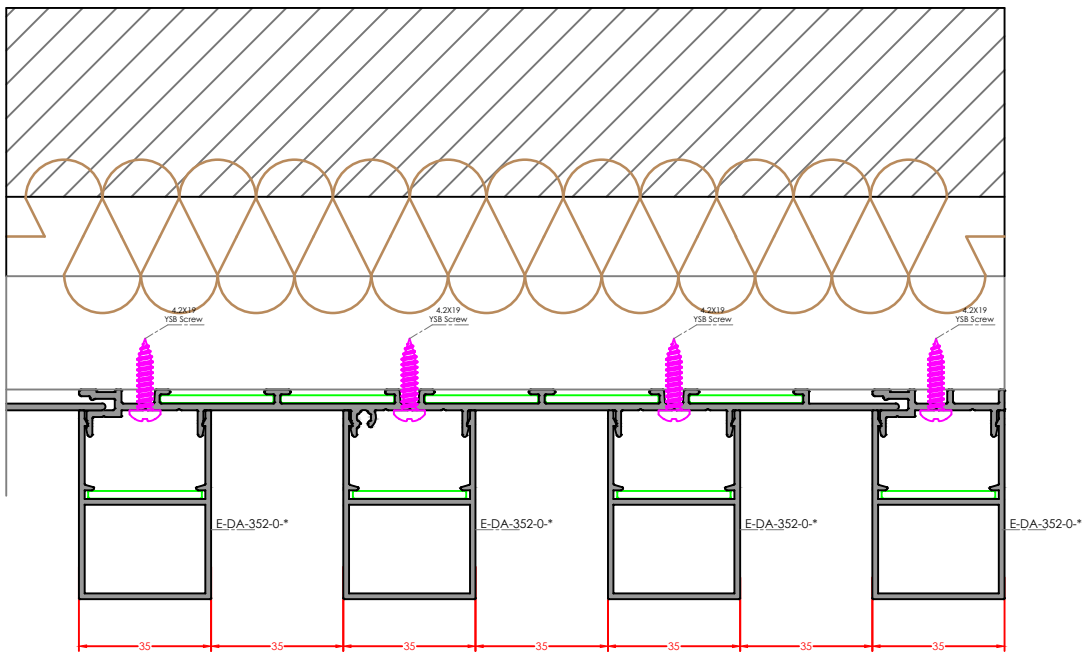

OUTSIDE

\* The selected color must be specified.

ALUMINIUM WINDOW SYSTEM TRANSITION VERTICAL DETAIL

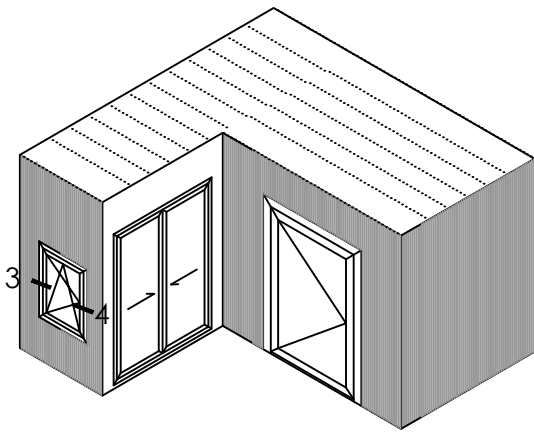

INSIDE

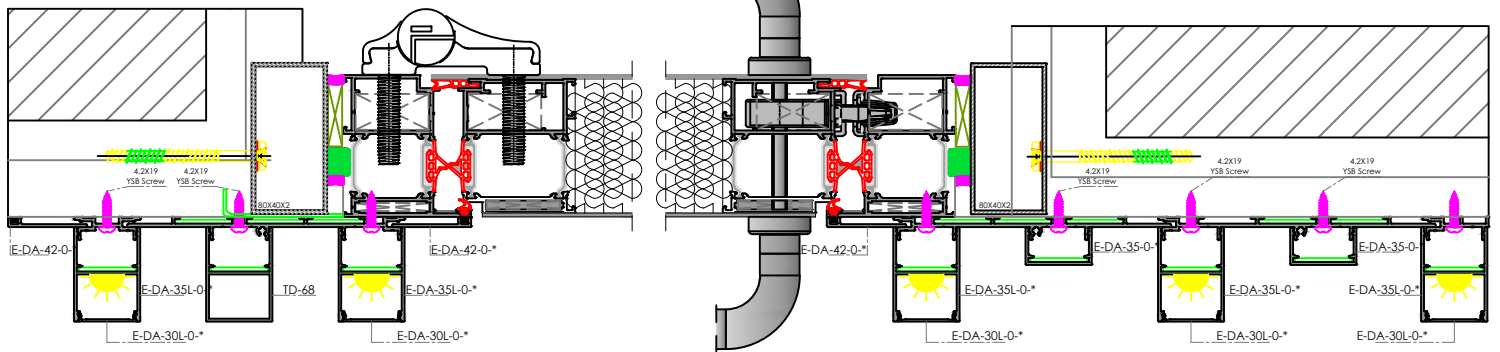

OUTSIDE

\* The selected color must be specified.

OUTWARD COVERED DETAIL

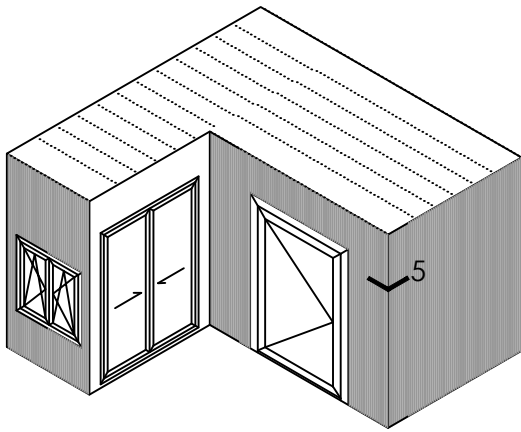

INSIDE

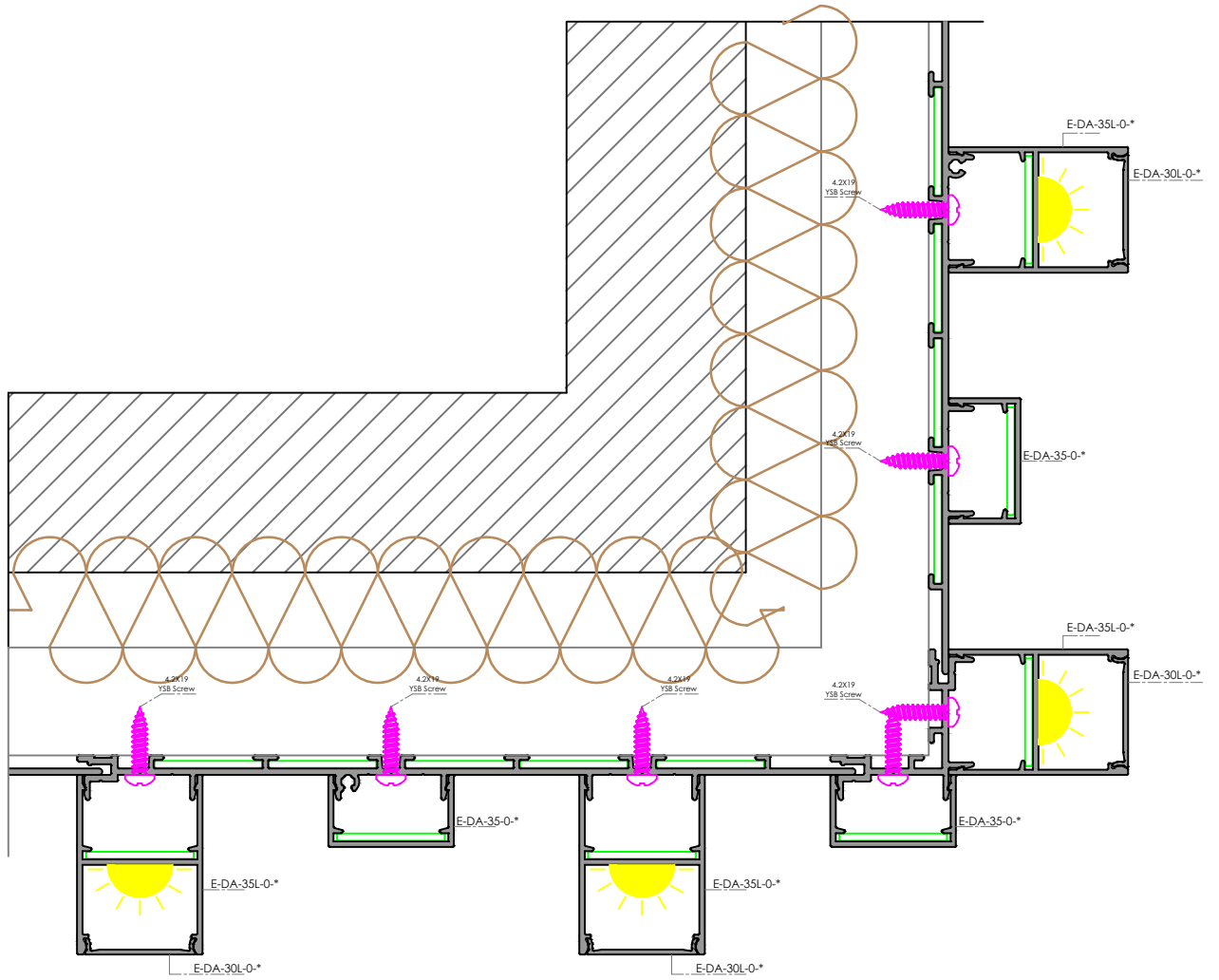

OUTSIDE

\* The selected color must be specified.

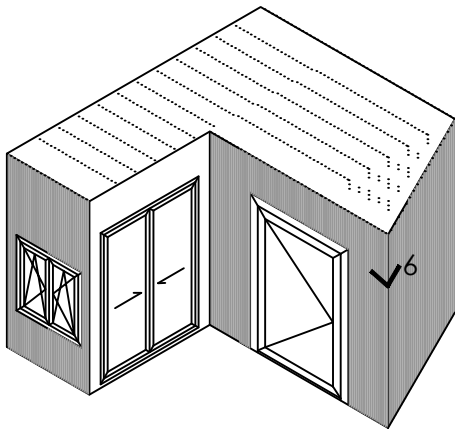

INSIDE

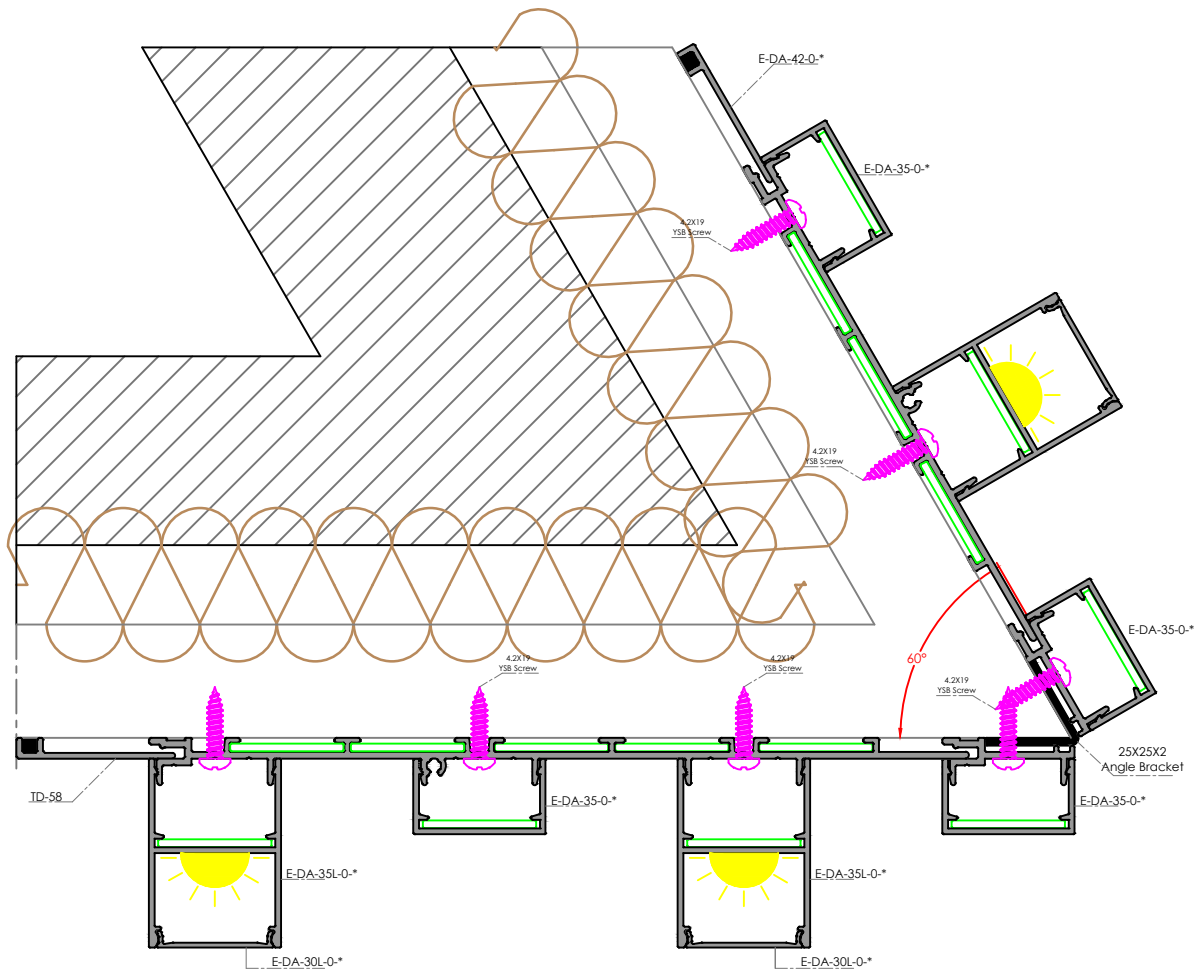

OUTSIDE

\* The selected color must be specified.

INWARD COVERED DETAIL

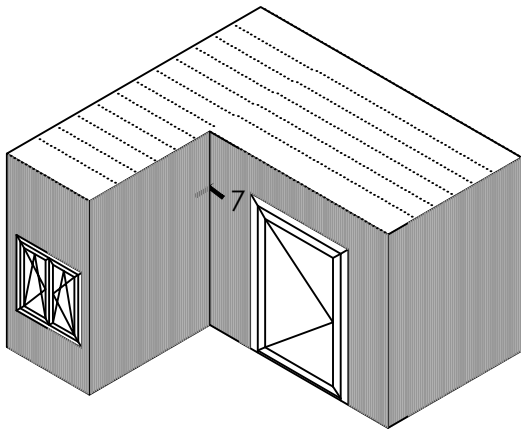

INSIDE

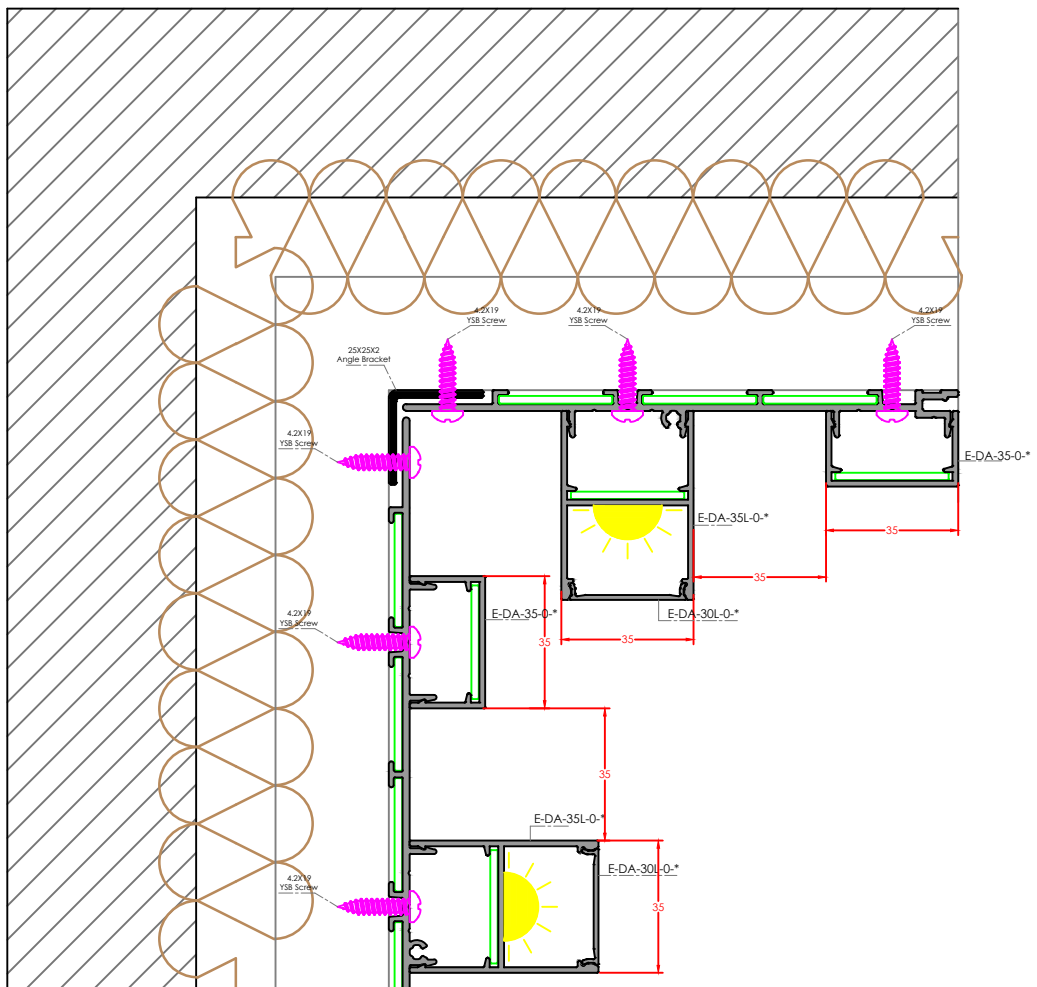

OUTSIDE

\* The selected color must be specified.



[www.tgpsystems.com](http://www.tgpsystems.com)

# DECOAL SERIES

105 COVERED FUNCTIONS

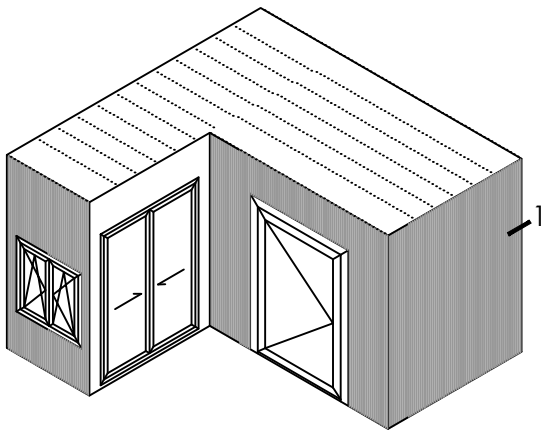

INSIDE

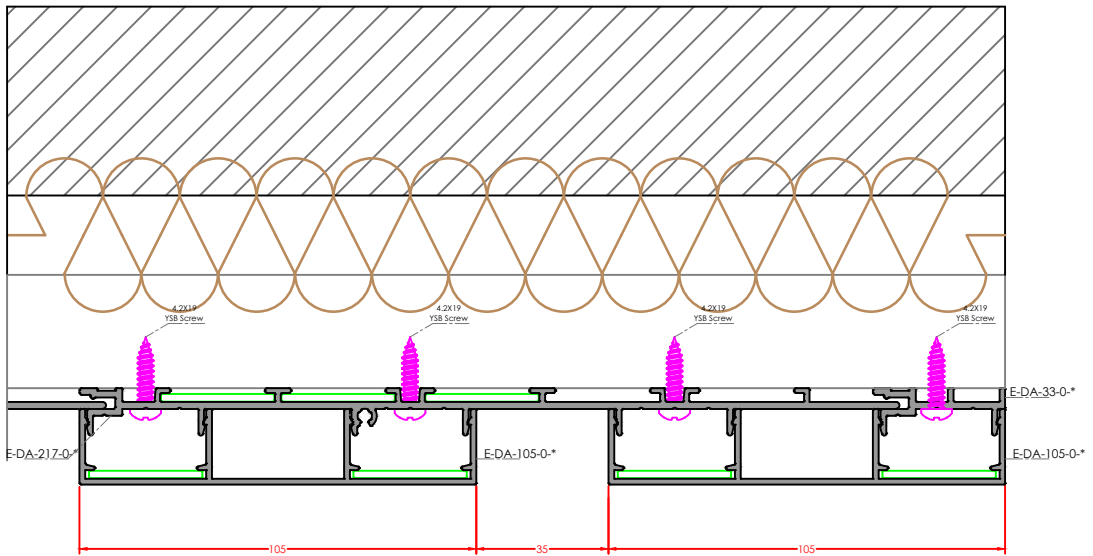

OUTSIDE

\* The selected color must be specified.

TRANSITIONAL COVERED VERTICAL DETAIL

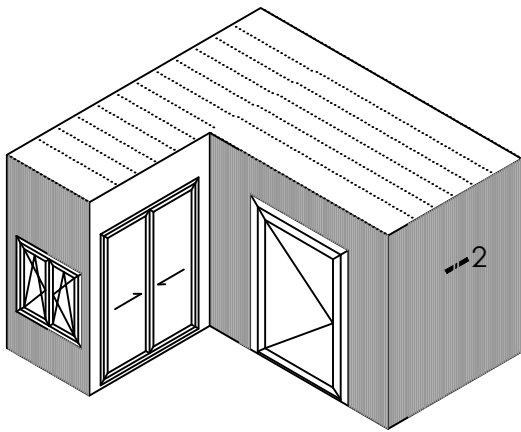

INSIDE

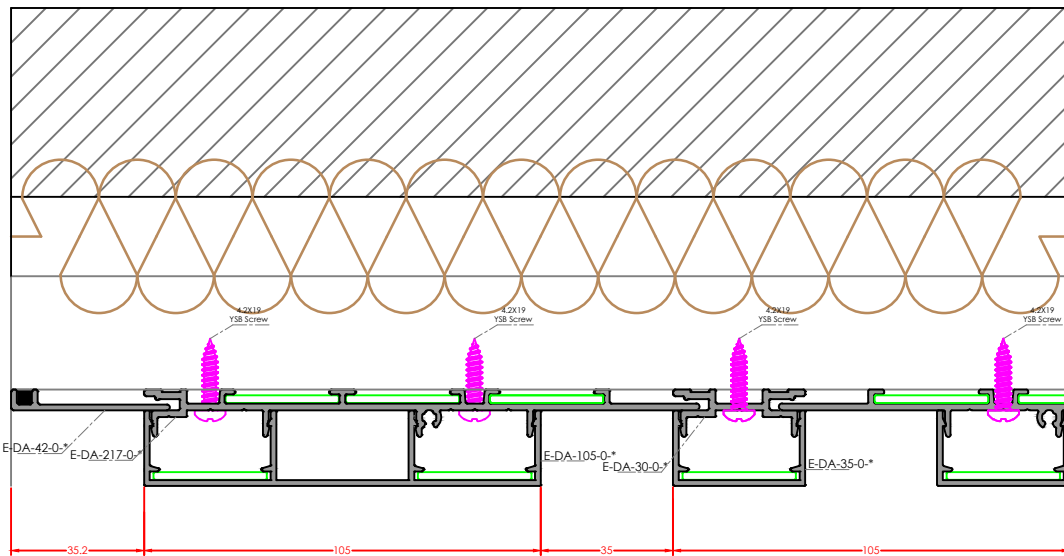

OUTSIDE

\* The selected color must be specified.

ALUMINIUM WINDOW SYSTEM TRANSITION VERTICAL DETAIL

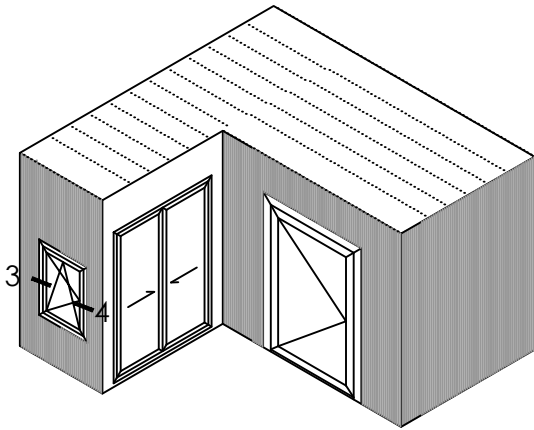

INSIDE

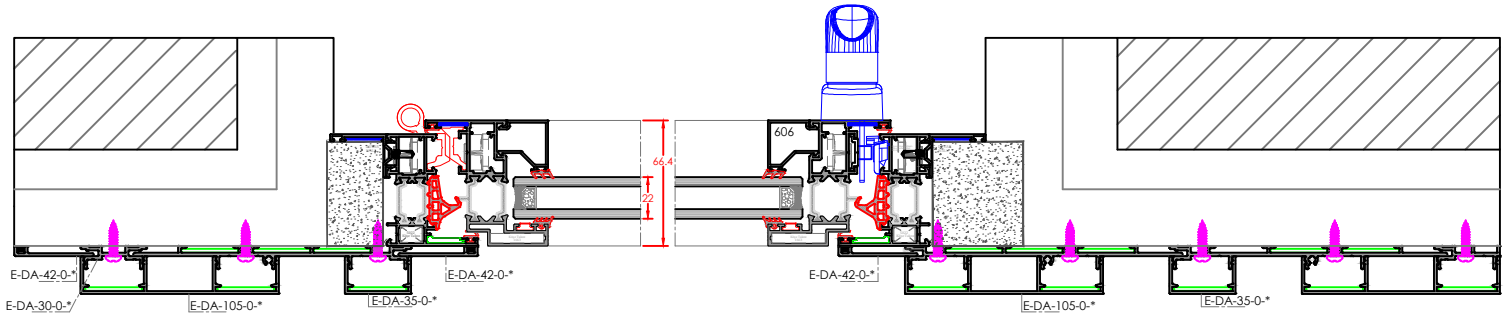

OUTSIDE

\* The selected color must be specified.

OUTWARD COVERED DETAIL

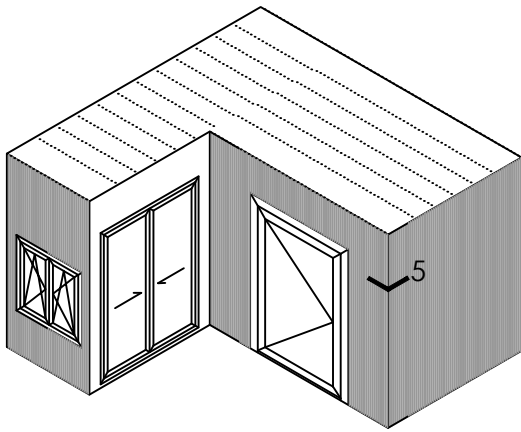

INSIDE

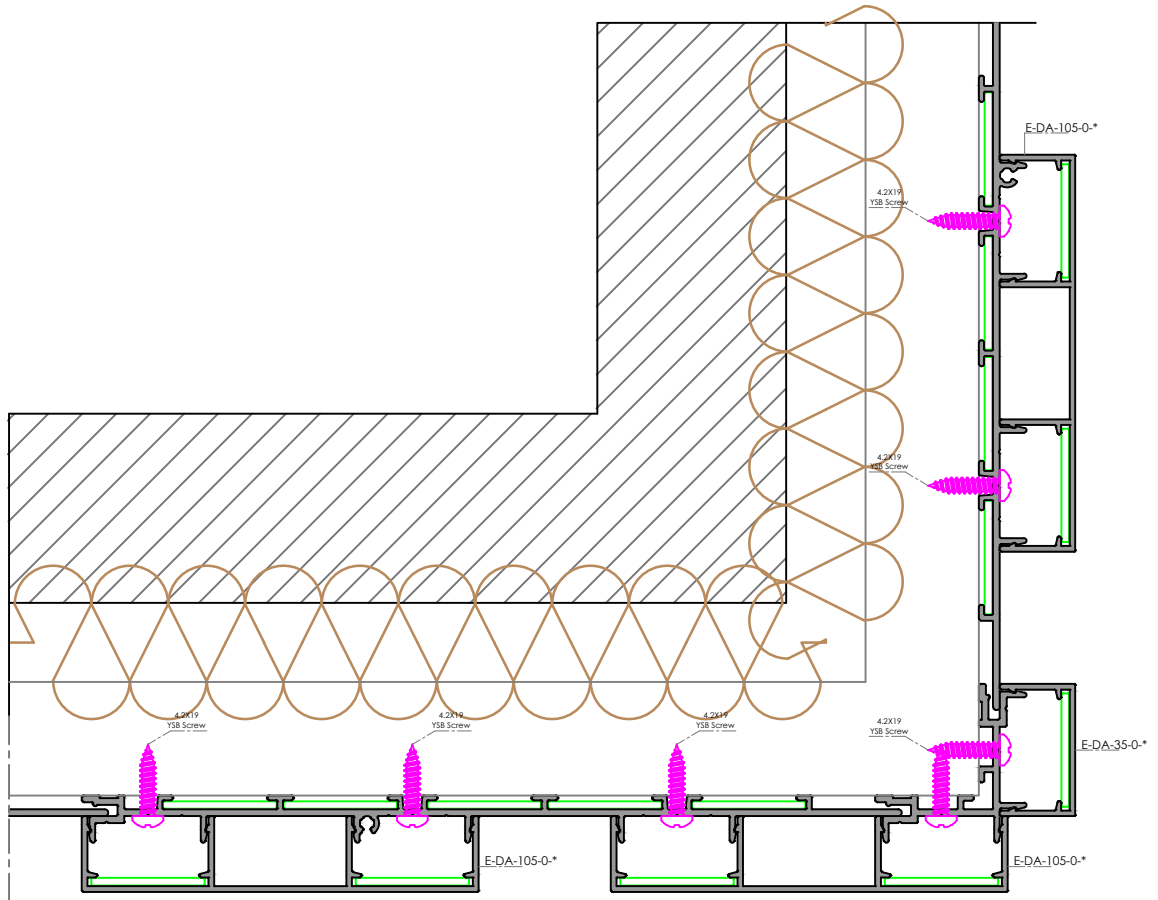

OUTSIDE

\* The selected color must be specified.

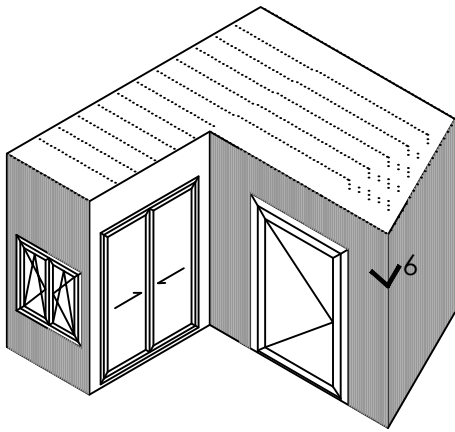

INSIDE

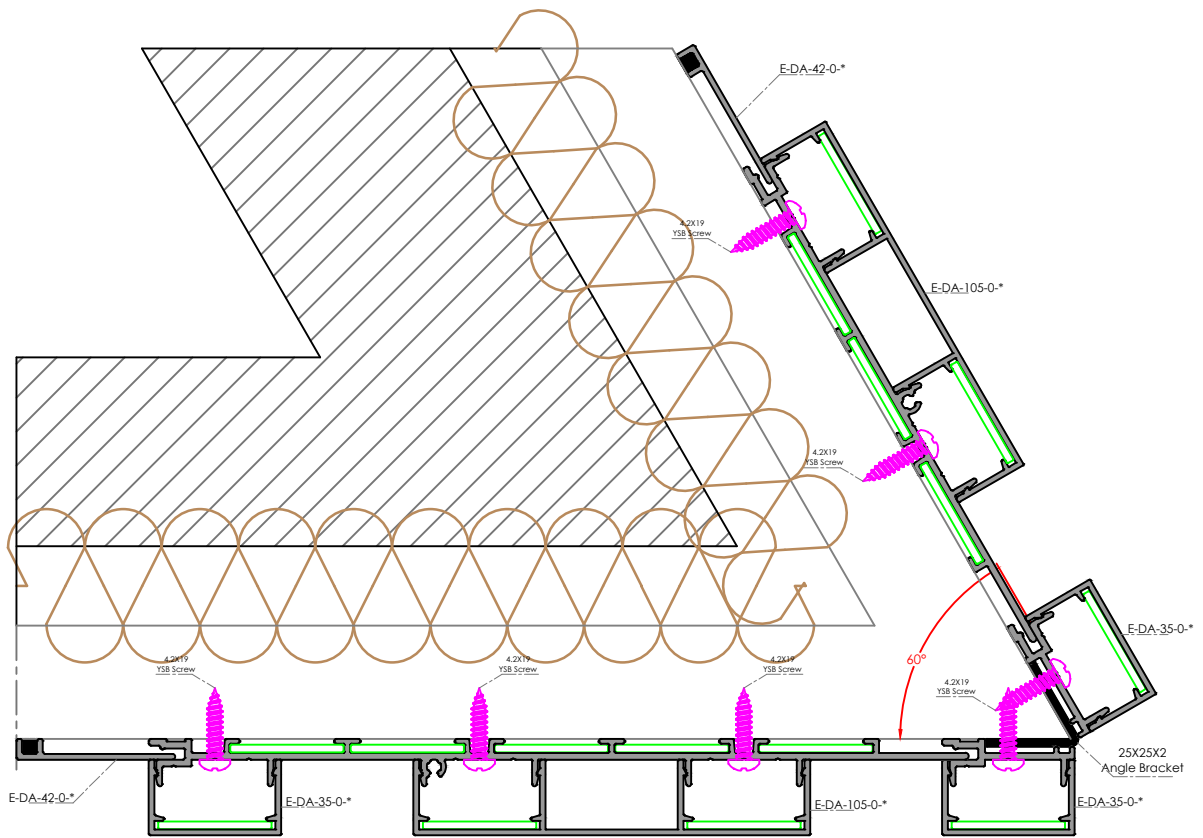

OUTSIDE

\* The selected color must be specified.

INWARD COVERED DETAIL

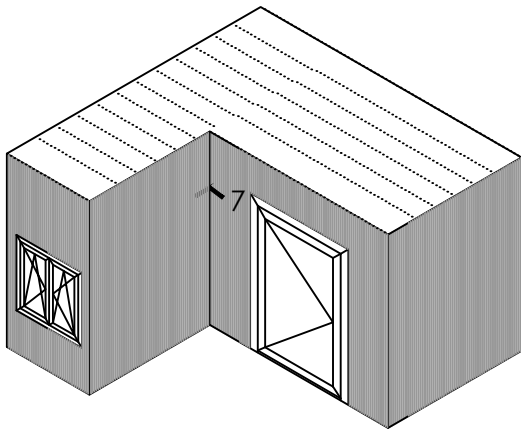

INSIDE

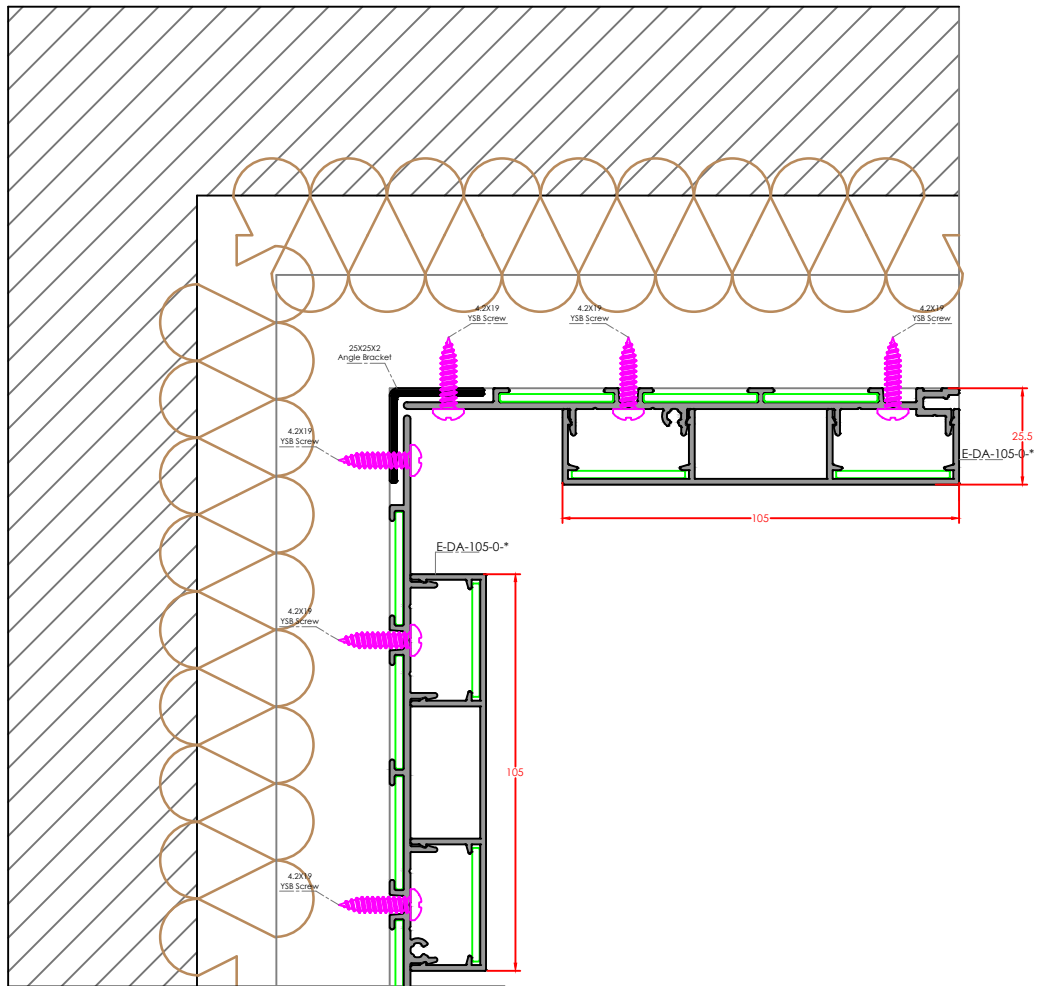

OUTSIDE

\* The selected color must be specified.



[www.tgpsystems.com](http://www.tgpsystems.com)

# DECOAL SERIES

75 COVERED FUNCTIONS

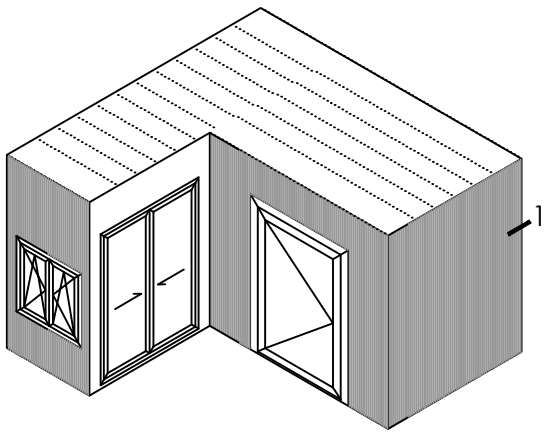

INSIDE

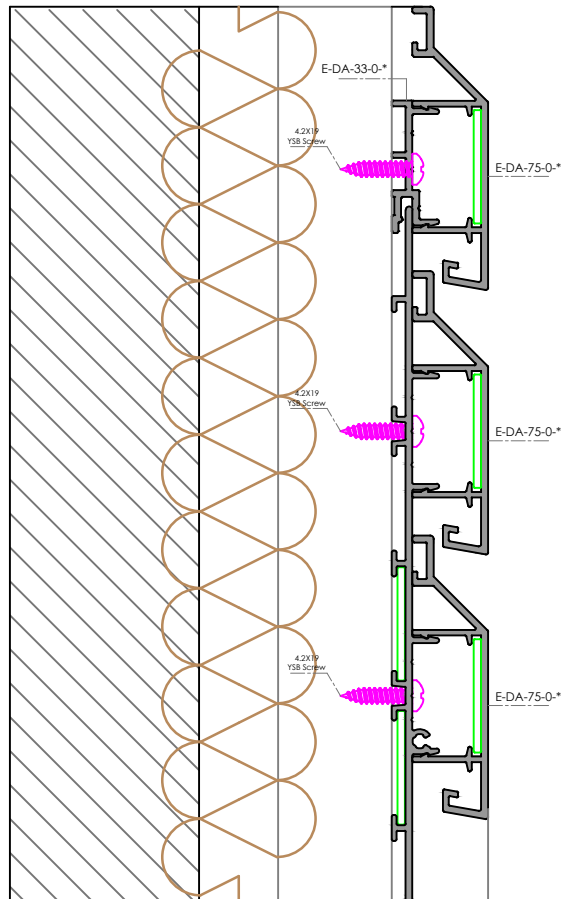

OUTSIDE

\* The selected color must be specified.

TRANSITIONAL COVERED VERTICAL DETAIL

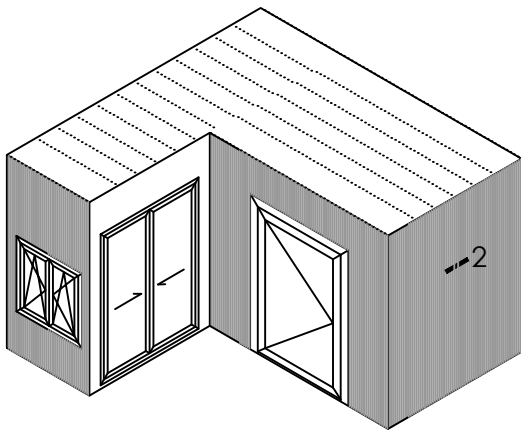

INSIDE

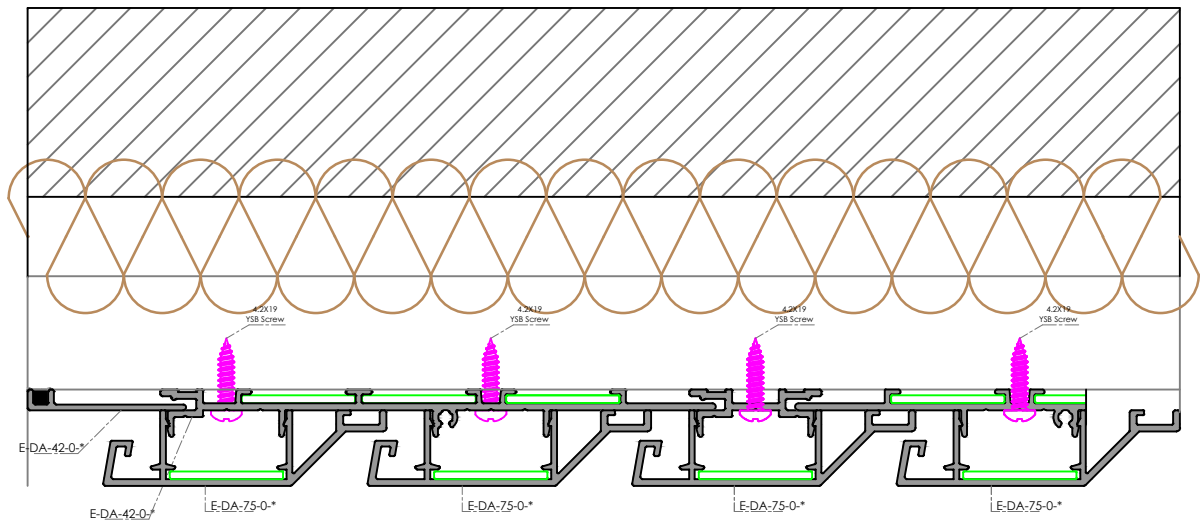

OUTSIDE

\* The selected color must be specified.

ALUMINIUM WINDOW SYSTEM TRANSITION VERTICAL DETAIL

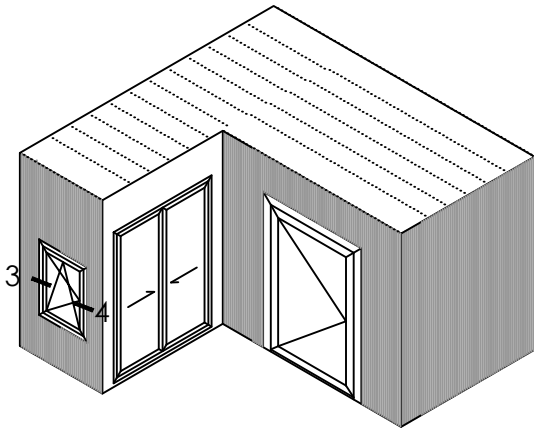

INSIDE

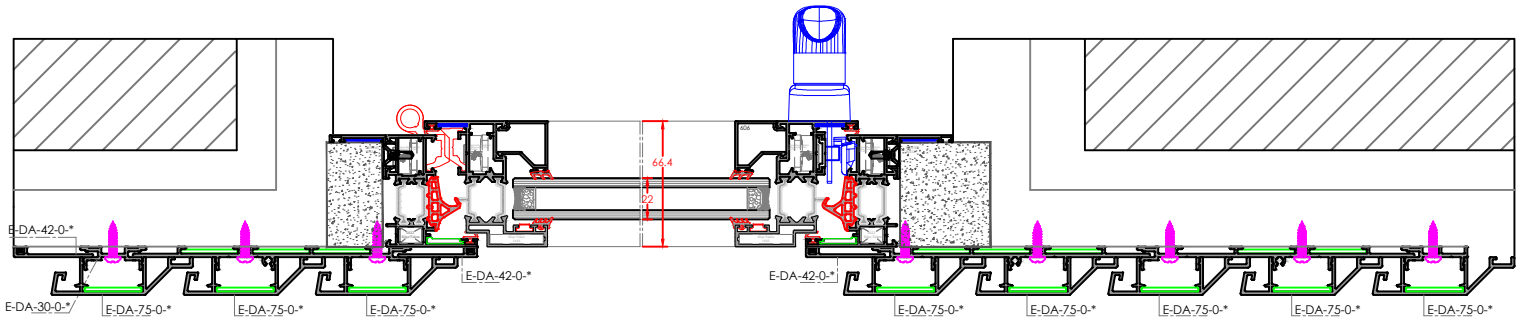

OUTSIDE

\* The selected color must be specified.

OUTWARD COVERED DETAIL

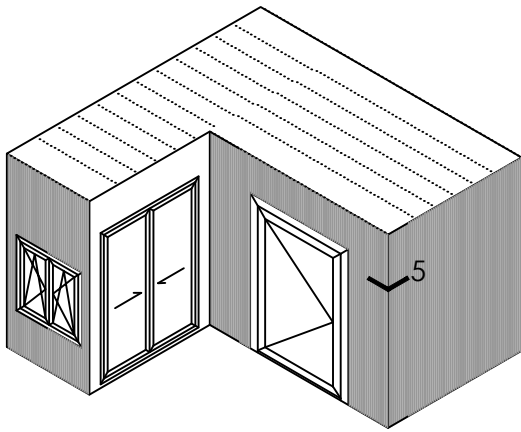

INSIDE

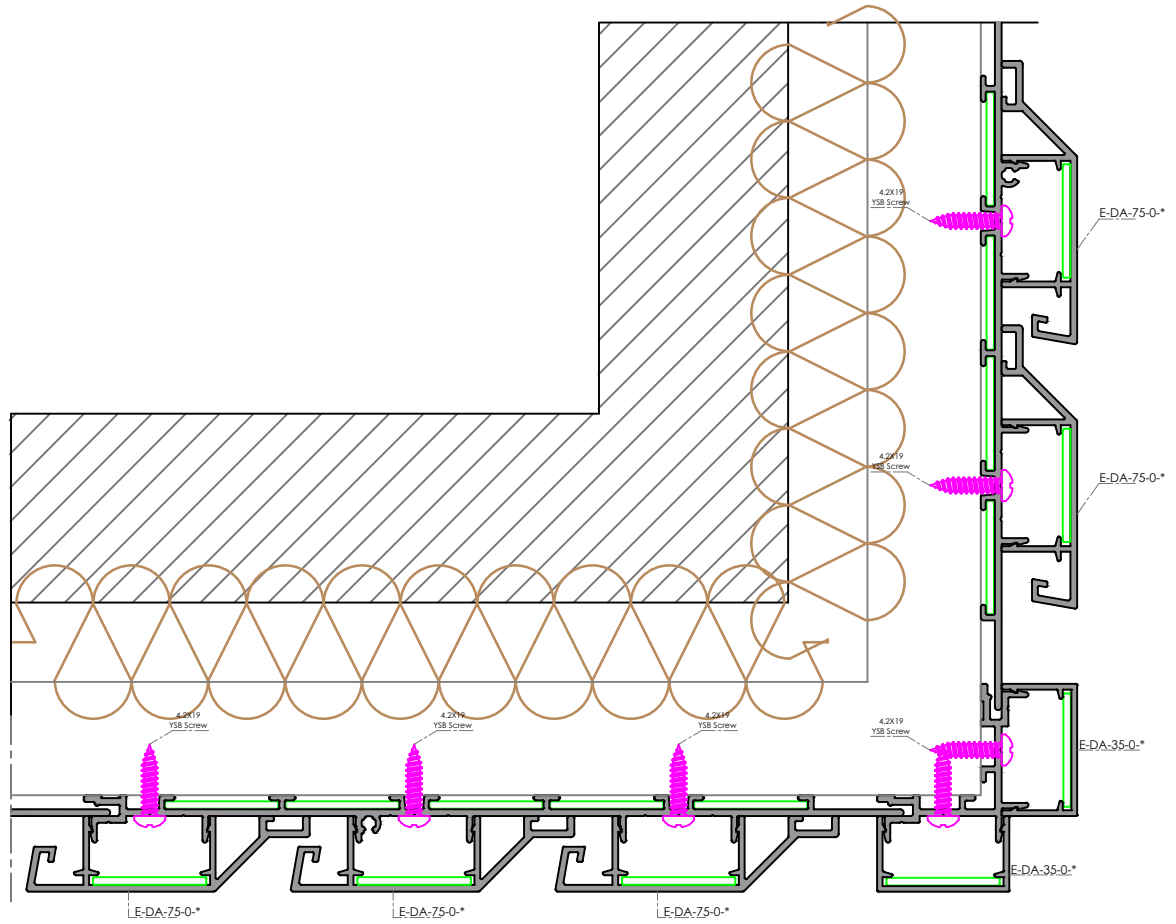

OUTSIDE

\* The selected color must be specified.

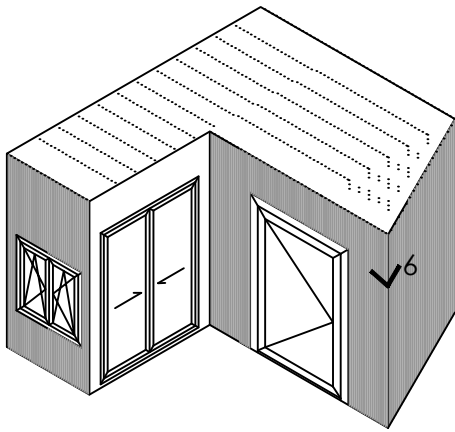

INSIDE

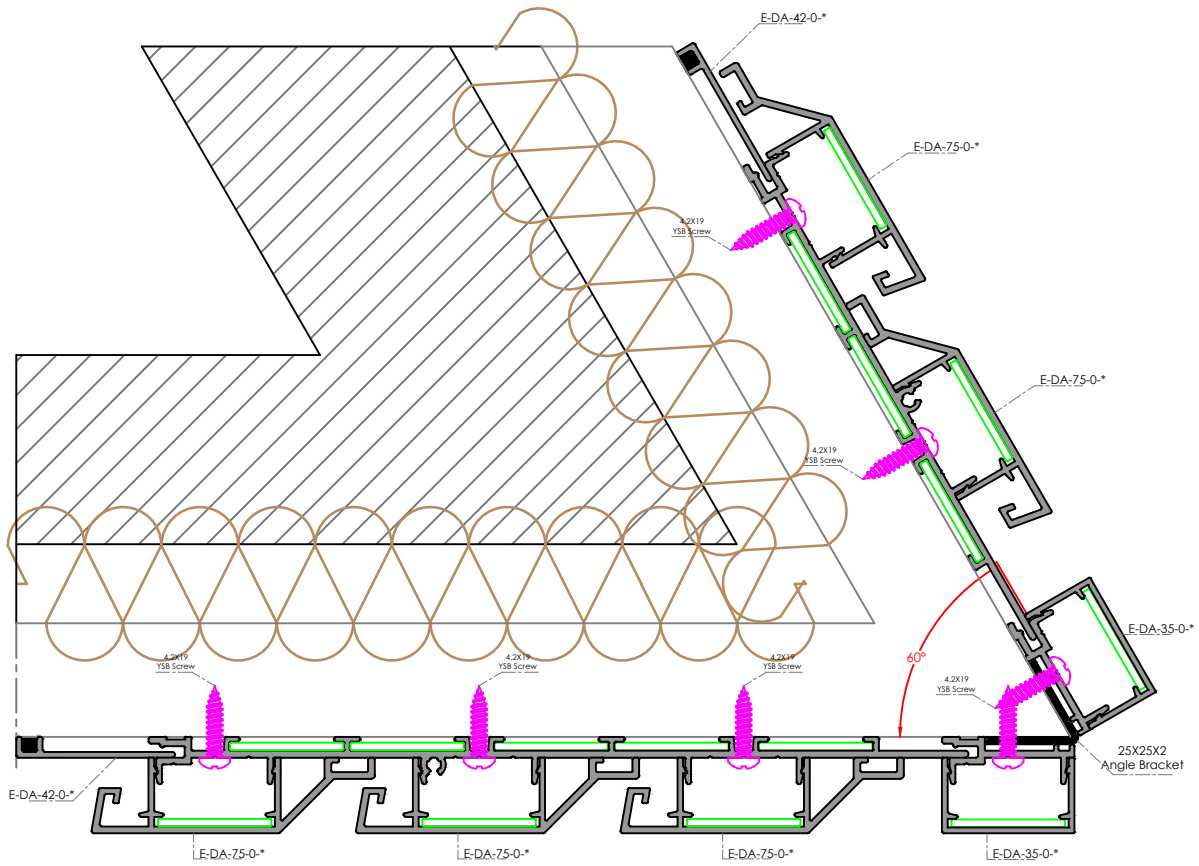

OUTSIDE

\* The selected color must be specified.

INWARD COVERED DETAIL

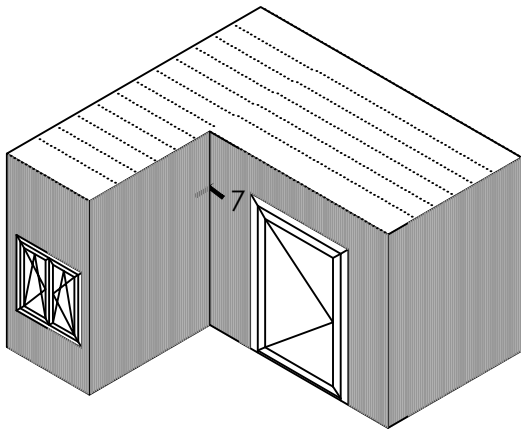

INSIDE

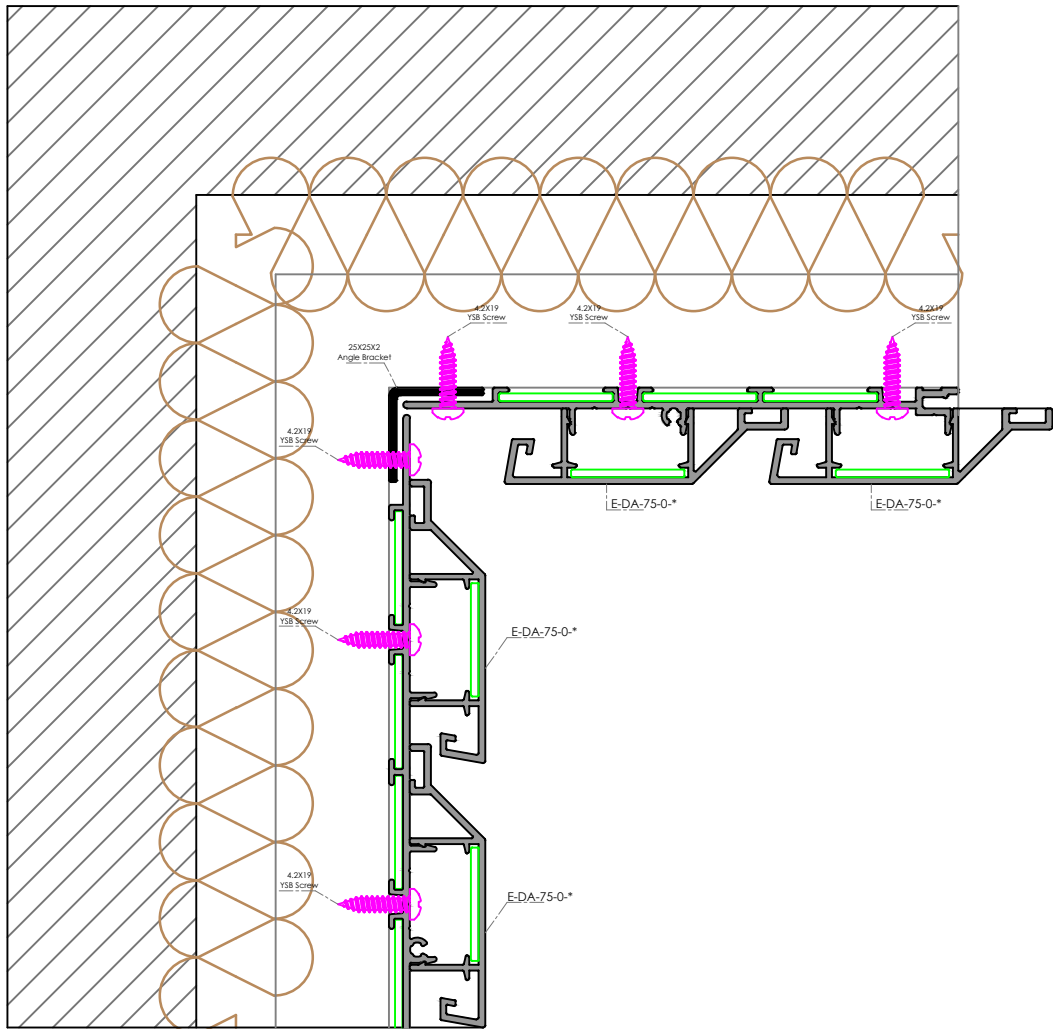

OUTSIDE

\* The selected color must be specified.



[www.tgpsystems.com](http://www.tgpsystems.com)