

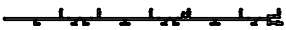





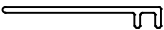

DECOAL SERIES

ALUMINIUM FACADE CLADDING
SYSTEM

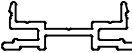
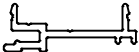
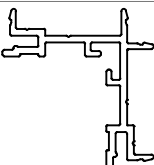
PROFILE SECTION	PROFILE CODE	PROFILE NAME	Jx cm ⁴	Jy cm ⁴	WEIGHT(kg/m)
	E-DA-217-0*	3 AXLE BODY PROFILE	-	-	1,504 kg/m
	E-DA-147-0*	2 AXLE BODY PROFILE	-	-	1,032 kg/m
	E-DA-42-0*	ENDING PROFILE	-	-	0,203 kg/m
	E-DA-33S-0*	STARTED PROFILE	-	-	0,313 kg/m
	E-DA-30-0*	TRANSITION PROFILE	-	-	0,343 kg/m
	E-DA-33-0*	TRANSITION PROFILE	-	-	0,294 kg/m
	E-DA-33C-0*	90° CORNER PROFILE	-	-	0,599 kg/m
	E-DA-35-0*	FINISH PROFILE (4 mm)	-	-	0,301 kg/m
	E-DA-75-0*	HORIZONTAL COVER PROFILE	-	-	0,694 kg/m
	E-DA-105-0*	COVER PROFILE	-	-	0,767 kg/m
	E-DA-35L-0*	LED APPLICATION COVER PROFILE	-	-	0,583 kg/m
	E-DA-30L-0*	LED COVER PROFILE	-	-	0,122 kg/m
	E-DA-352-0*	COVER PROFILE	-	-	0,686 kg/m
	E-DA-35-0*	COVER PROFILE	-	-	0,311 kg/m

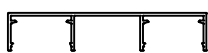
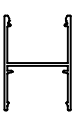
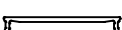
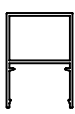

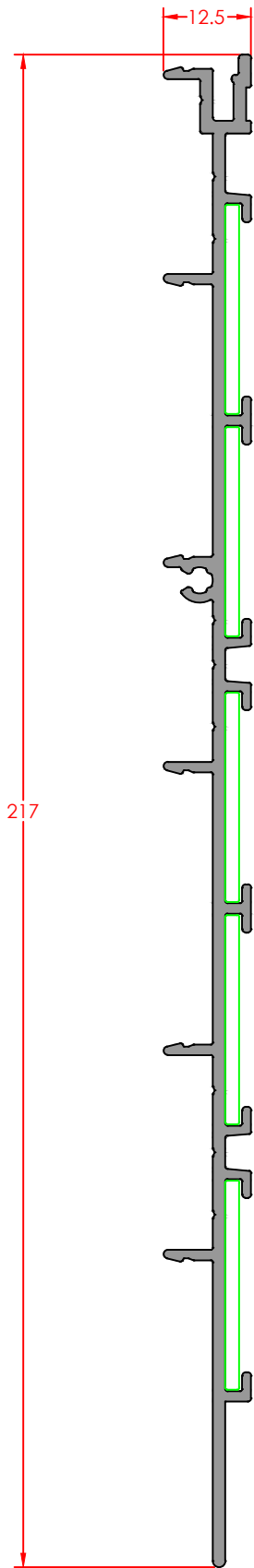
3 AXLE BODY PROFILE
Profile Code: E-DA-217-0-
Weight/mt: 1,504

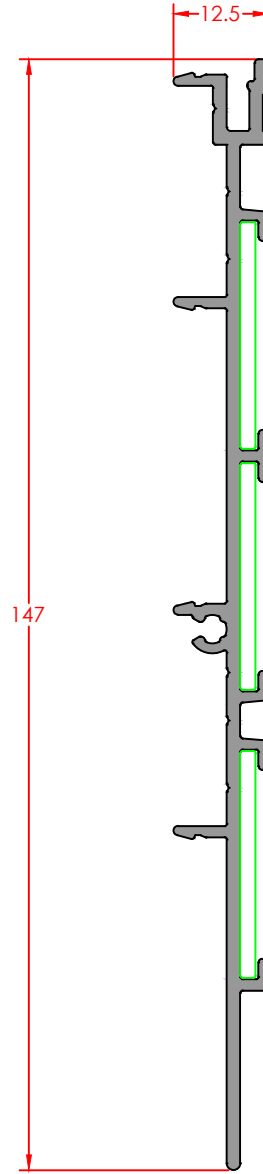

2 AXLE BODY PROFILE
Profile Code: E-DA-147-0-
Weight/mt: 1,032

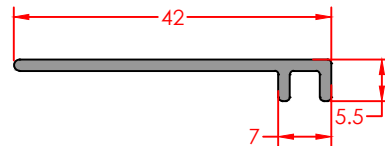

ENDING PROFILE
Profile Code: E-DA-42-0-
Weight/mt: 0,203

* The selected color must be specified.

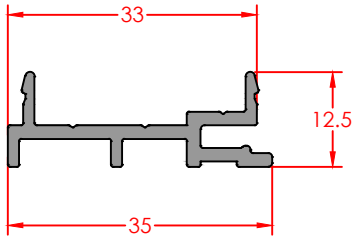

STARTED PROFILE
Profile Code: E-DA-33S-0-
Weight/mt: 0,313

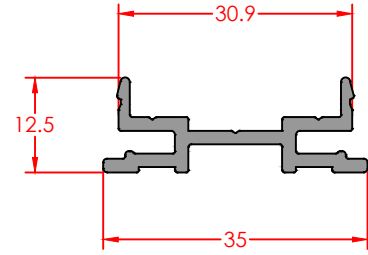

TRANSITION PROFILE
Profile Code: E-DA-30-0-
Weight/mt: 0,343

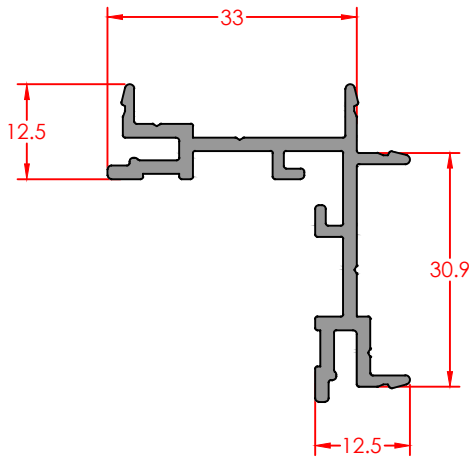

90° CORNER PROFILE
Profile Code: E-DA-33C-0-
Weight/mt: 0,599

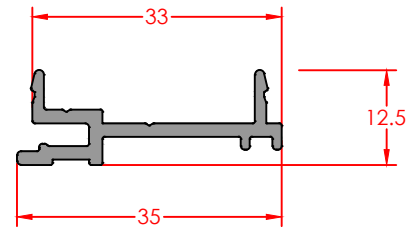

TRANSITION PROFILE
Profile Code: E-DA-33-0-
Weight/mt: 0,294

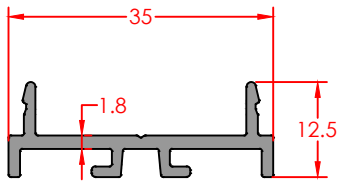

FINISHED PROFILE (4 mm)
Profile Code: E-DA-35-0-
Weight/mt: 0,301

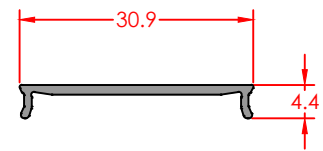

LED COVER PROFILE
Profile Code: E-DA-30L-0-
Weight/mt: 0,122

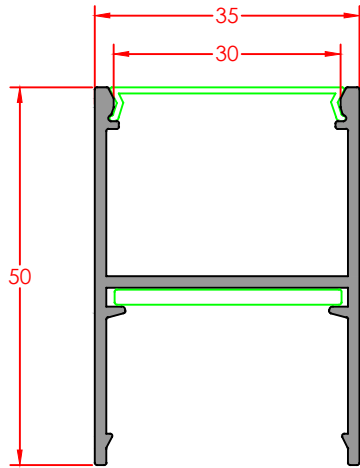

LED APPLICATION COVER PROFILE
 Profile Code: E-DA-35L-0-
 Weight/mt: 0,583

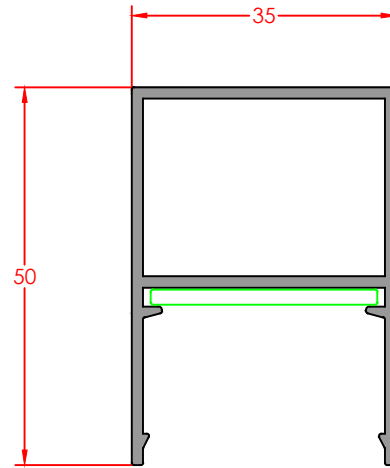

COVER PROFILE
 Profile Code: E-DA-352-0-
 Weight/mt: 0,686

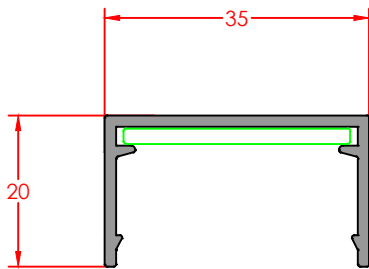

COVER PROFILE
 Profile Code: E-DA-35-0-
 Weight/mt: 0,311

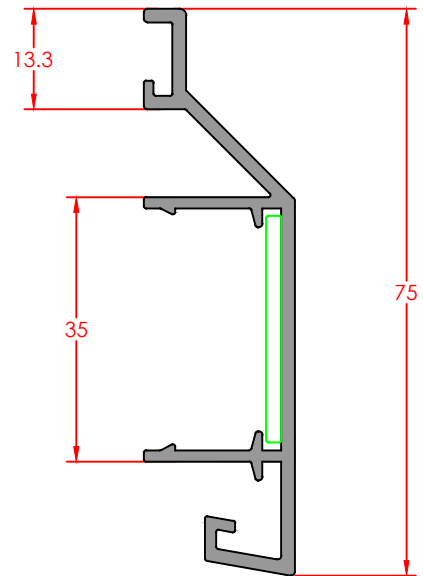

HORIZONTAL COVER PROFILE
 Profile Code: E-DA-75-0-
 Weight/mt: 0,694

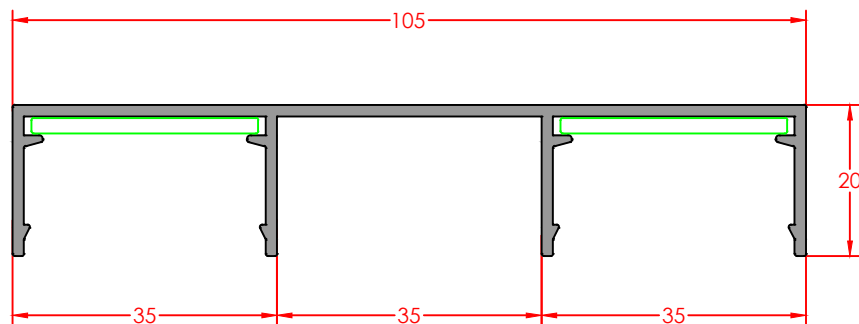

SIDE COVER PROFILE
 Profile Code: E-DA-105-0-
 Weight/mt: 0,767

* The selected color must be specified.

DECOAL SERIES

35 COVERED FUNCTIONS

COVERED VERTICAL DETAIL

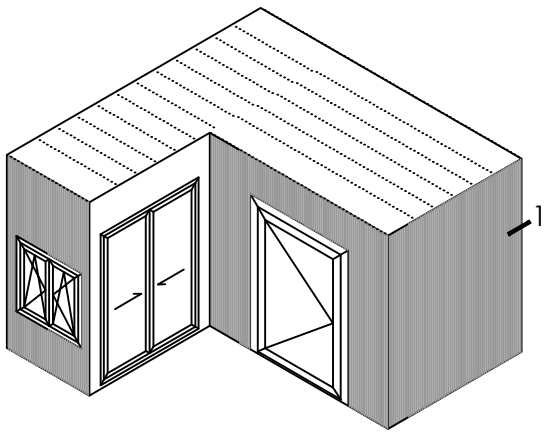

INSIDE

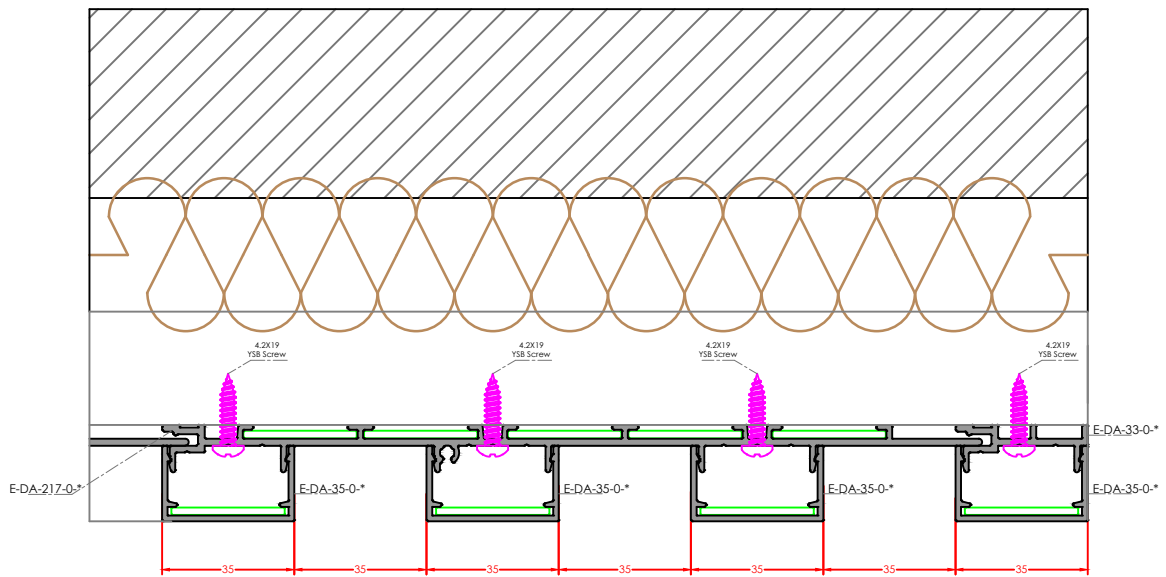

OUTSIDE

* The selected color must be specified.

TRANSITIONAL COVERED VERTICAL DETAIL

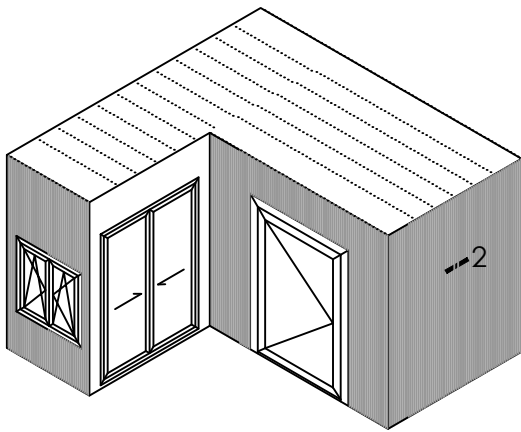

INSIDE

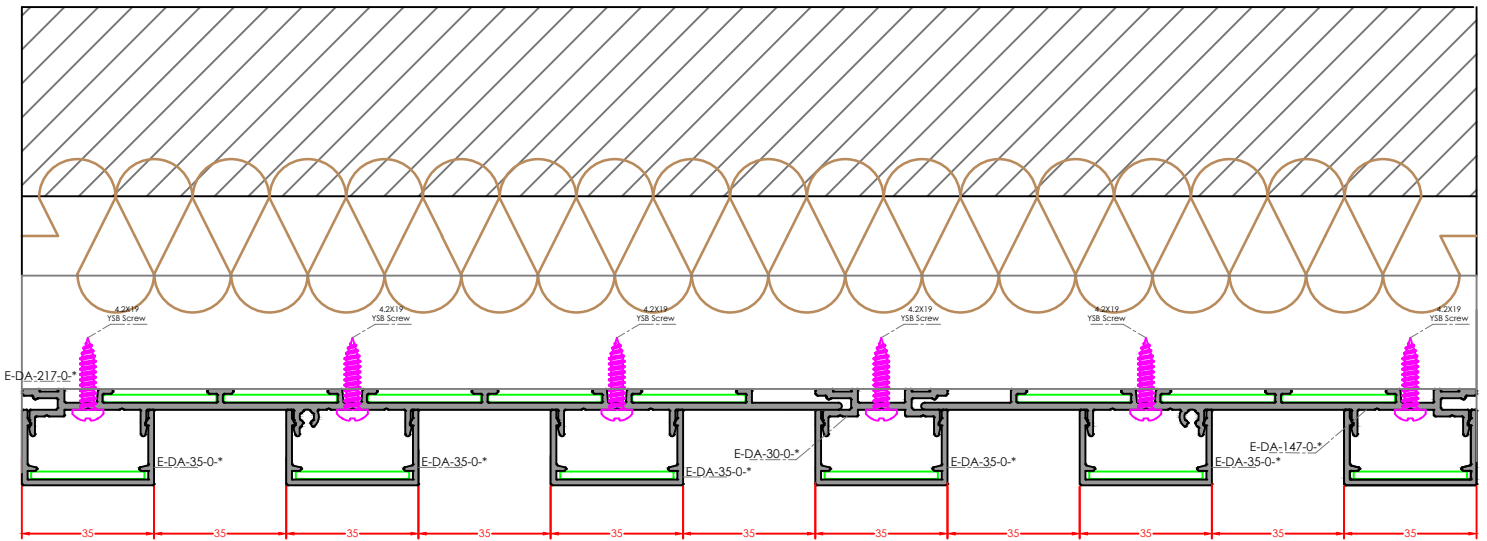

OUTSIDE

* The selected color must be specified.

ALUMINIUM WINDOW SYSTEM TRANSITION VERTICAL DETAIL

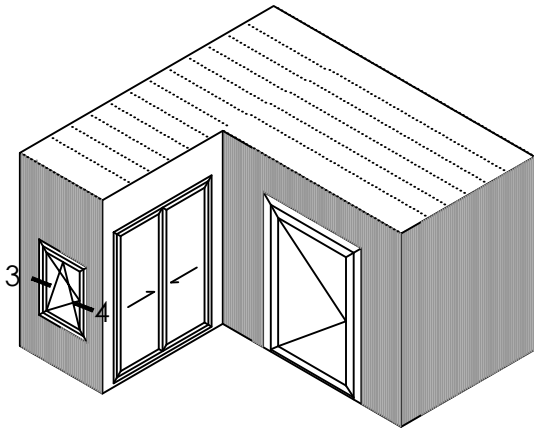

INSIDE

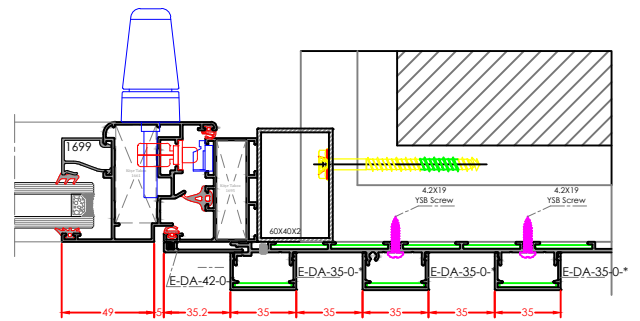
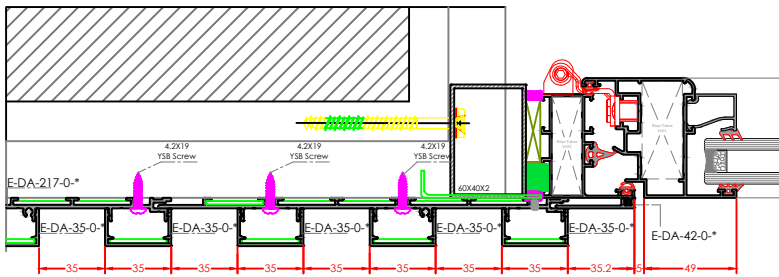

OUTSIDE

* The selected color must be specified.

OUTWARD COVERED DETAIL

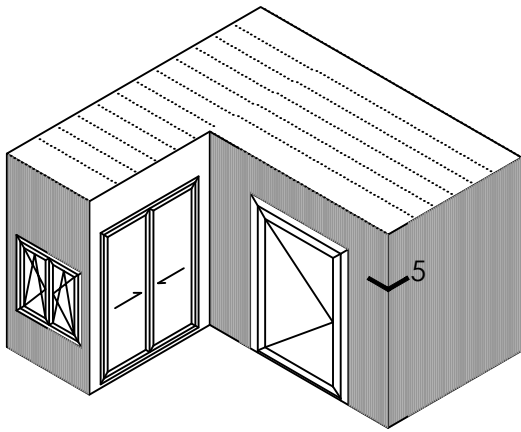

INSIDE

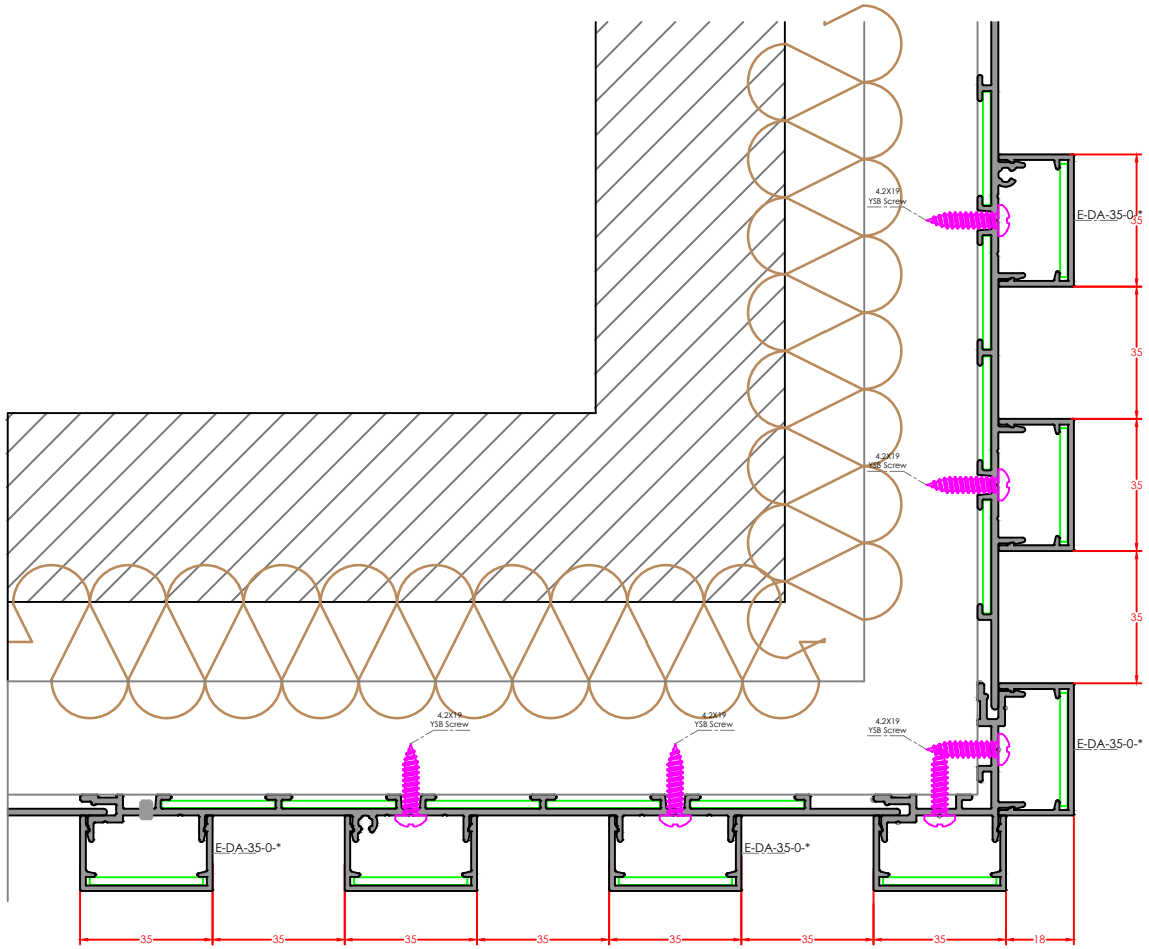

OUTSIDE

* The selected color must be specified.

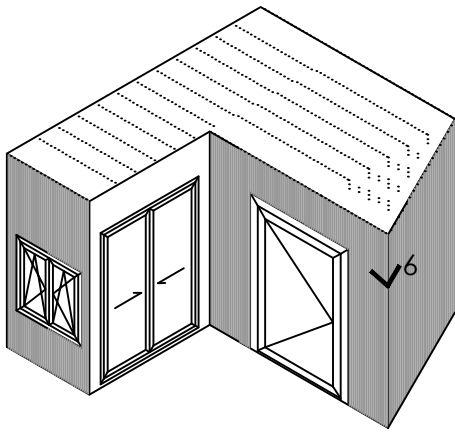

INSIDE

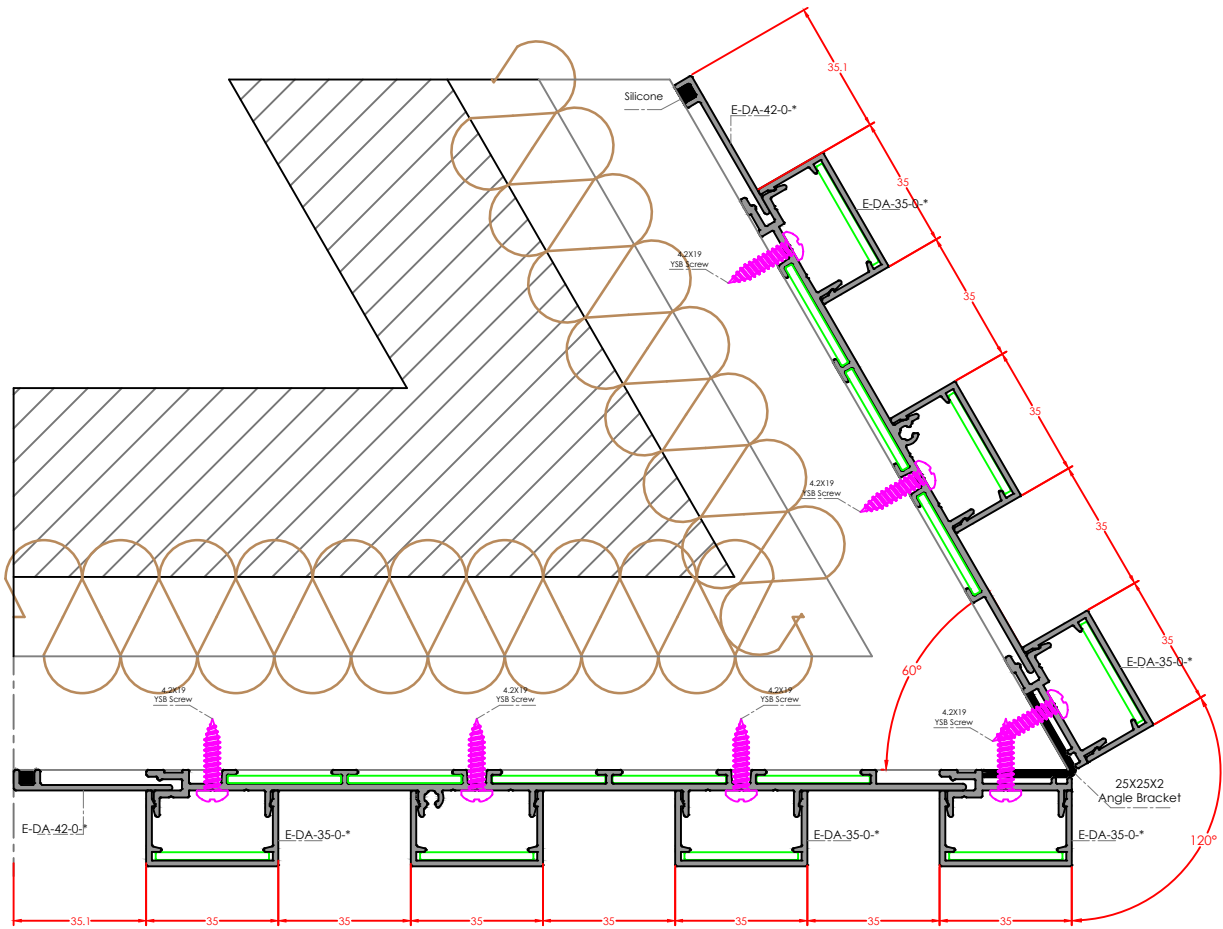

OUTSIDE

* The selected color must be specified.

INWARD COVERED DETAIL

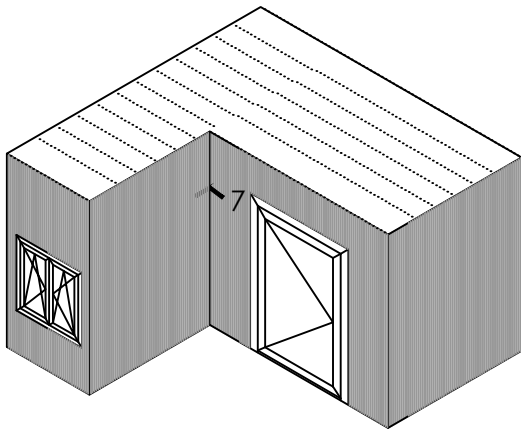

INSIDE

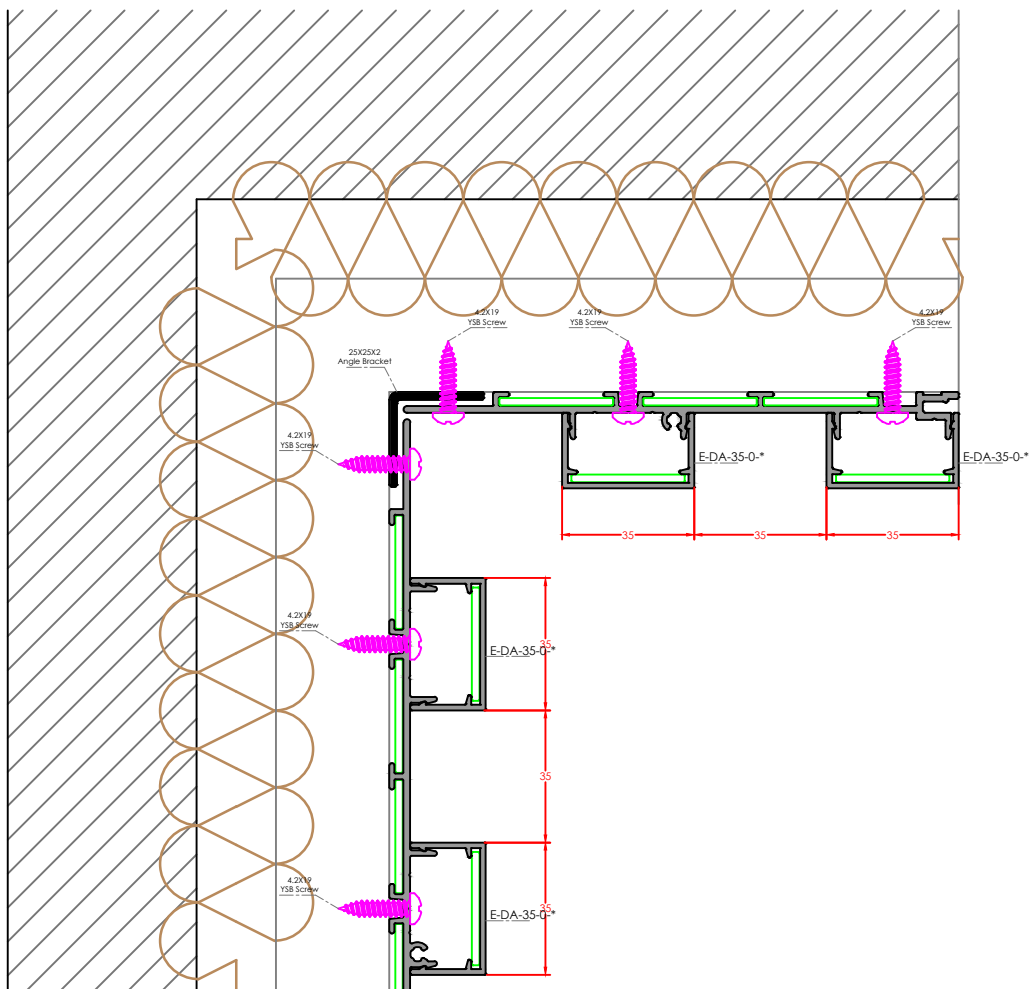

OUTSIDE

* The selected color must be specified.



www.tgpsystems.com

DECOAL SERIES

35L COVERED FUNCTIONS

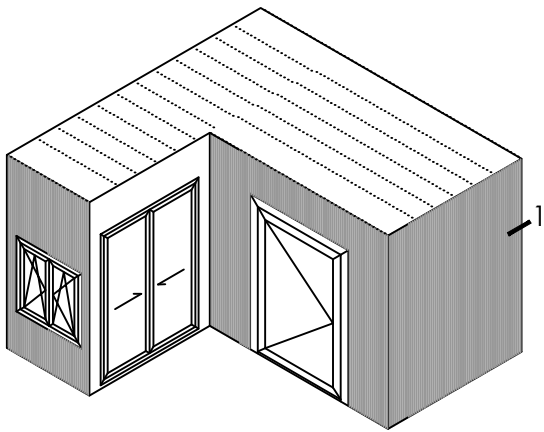

INSIDE

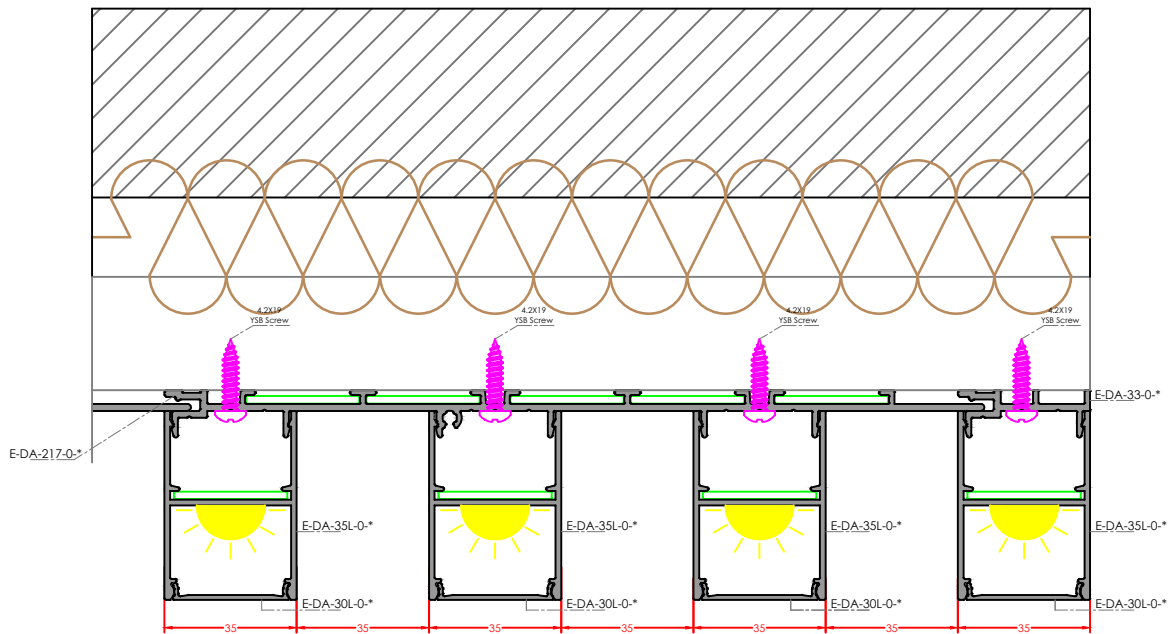

OUTSIDE

* The selected color must be specified.

TRANSITIONAL COVERED VERTICAL DETAIL

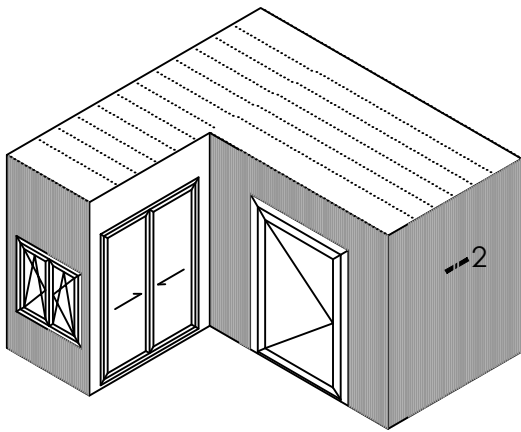

INSIDE

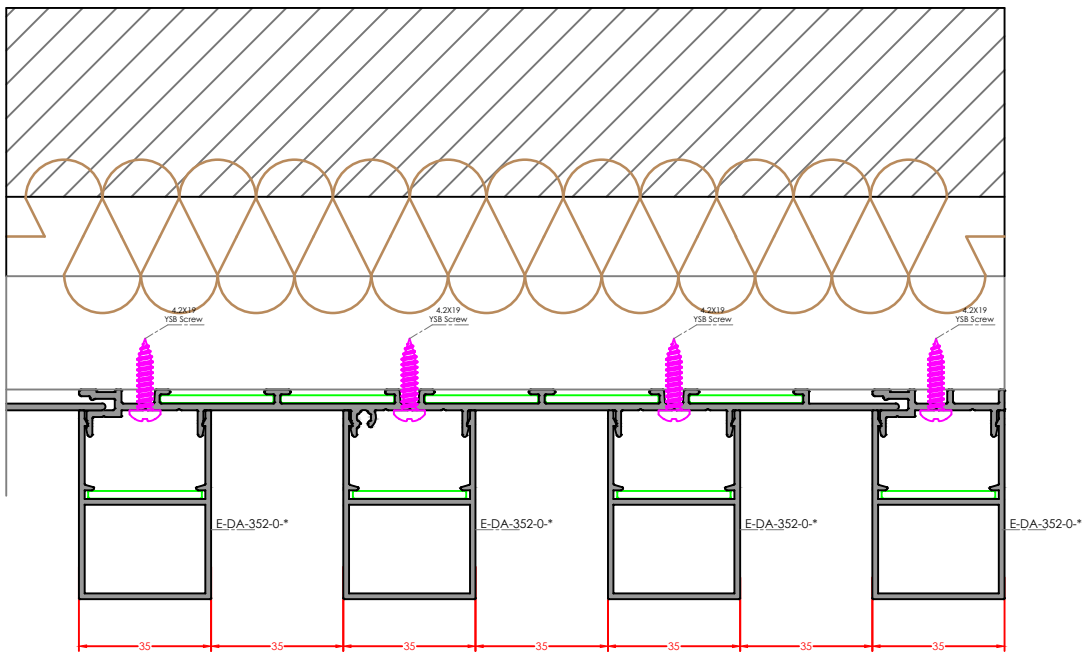

OUTSIDE

* The selected color must be specified.

ALUMINIUM WINDOW SYSTEM TRANSITION VERTICAL DETAIL

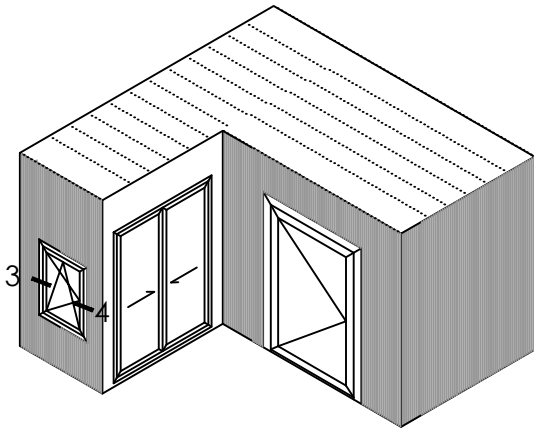

INSIDE

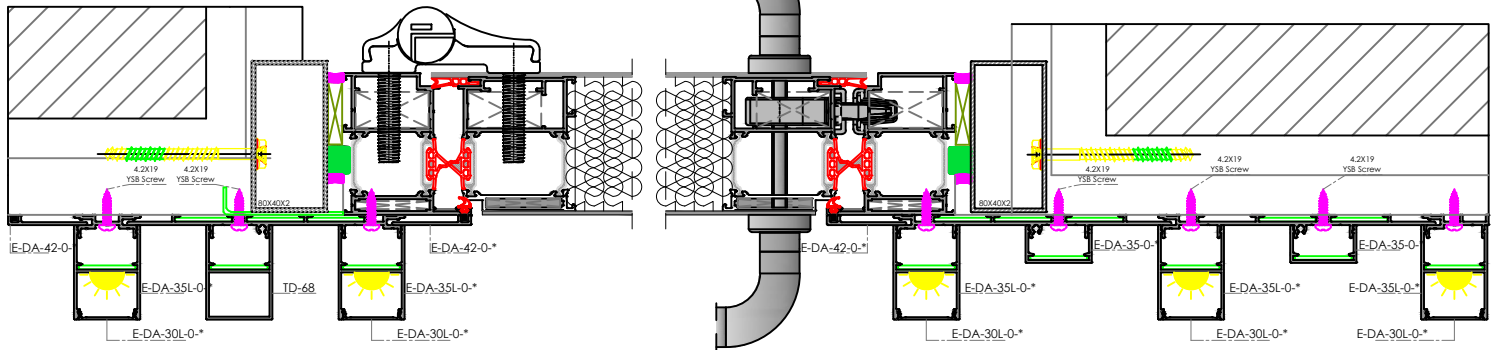

OUTSIDE

* The selected color must be specified.

OUTWARD COVERED DETAIL

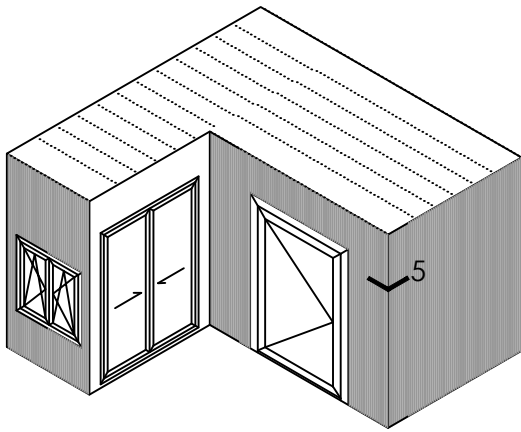

INSIDE

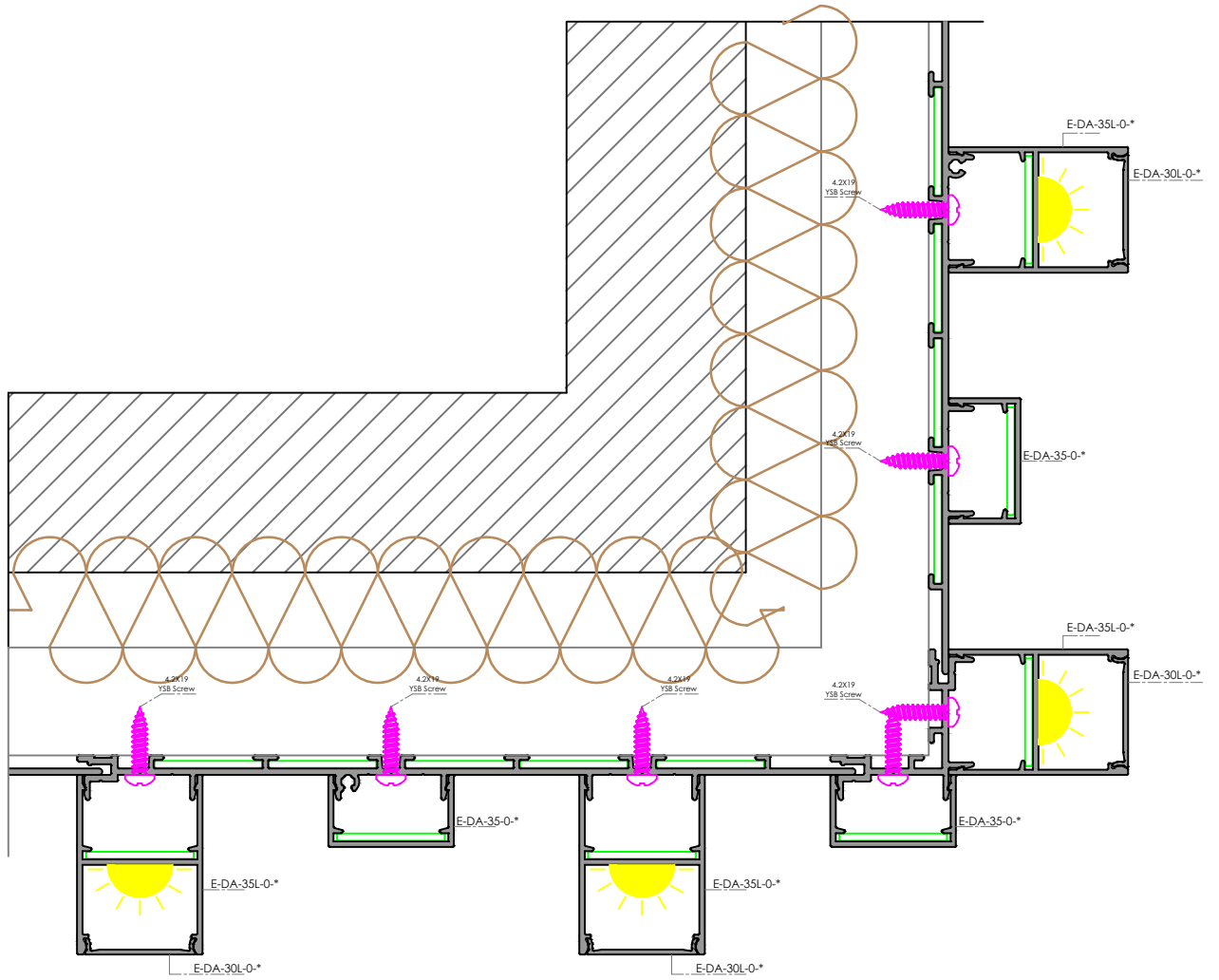

OUTSIDE

* The selected color must be specified.

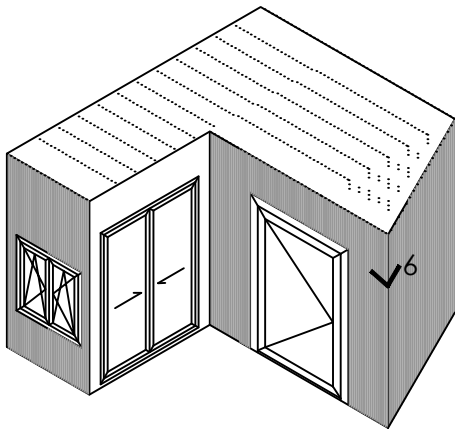

INSIDE

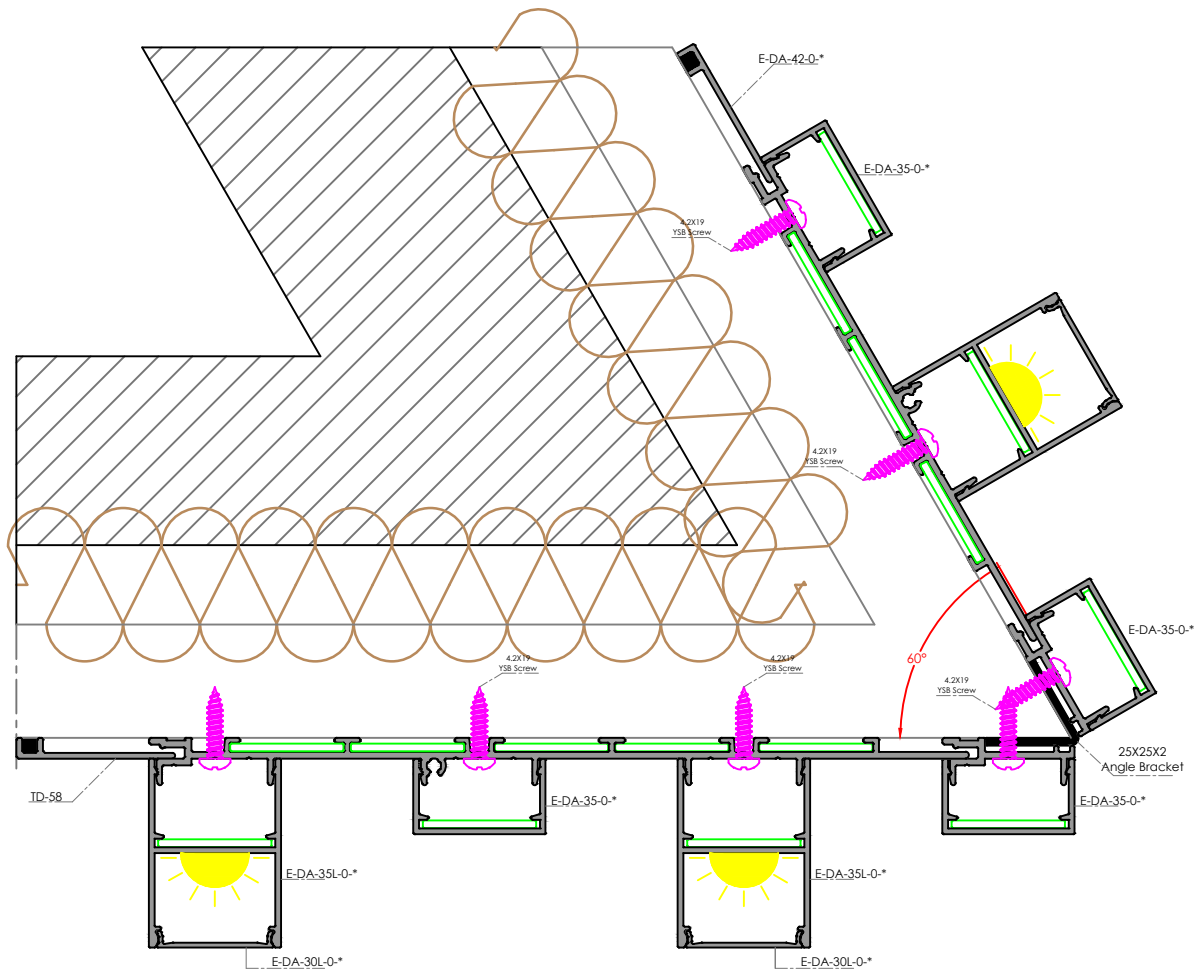

OUTSIDE

* The selected color must be specified.

INWARD COVERED DETAIL

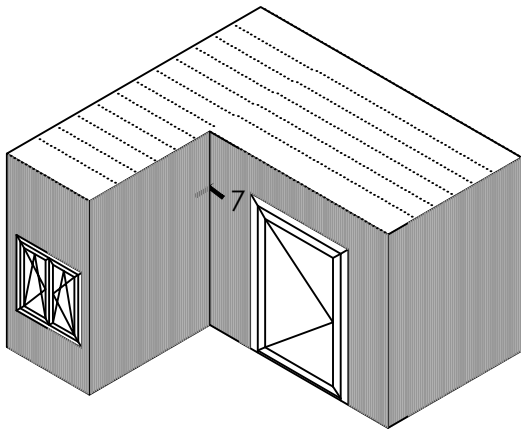

INSIDE

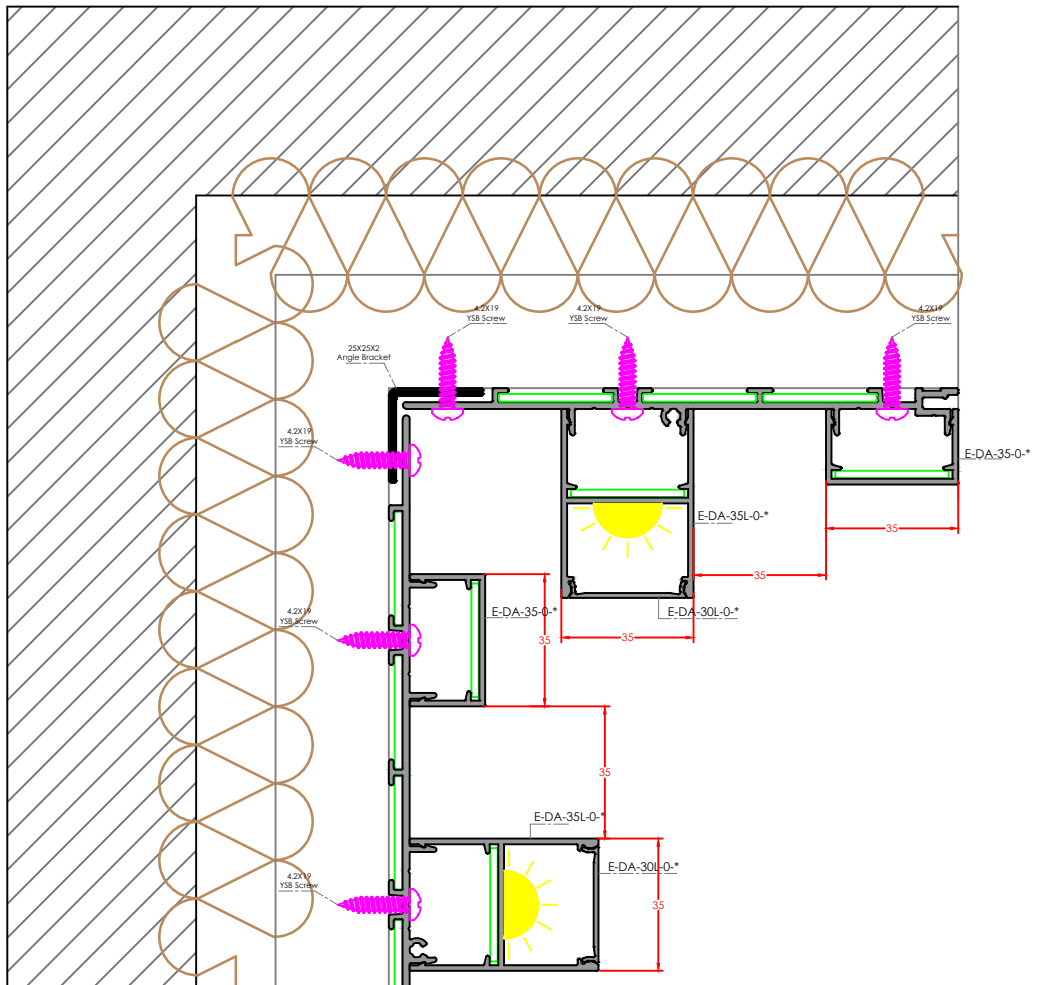

OUTSIDE

* The selected color must be specified.



www.tgpsystems.com

DECOAL SERIES

105 COVERED FUNCTIONS

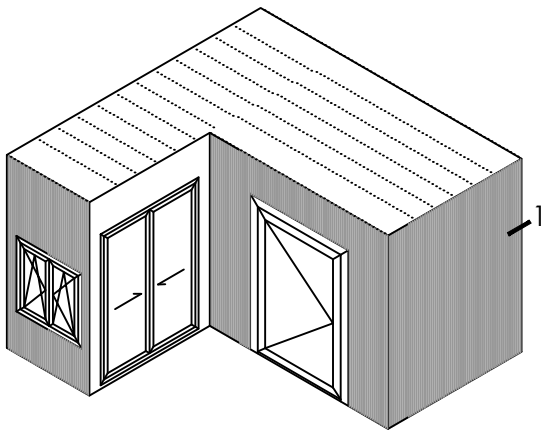

INSIDE

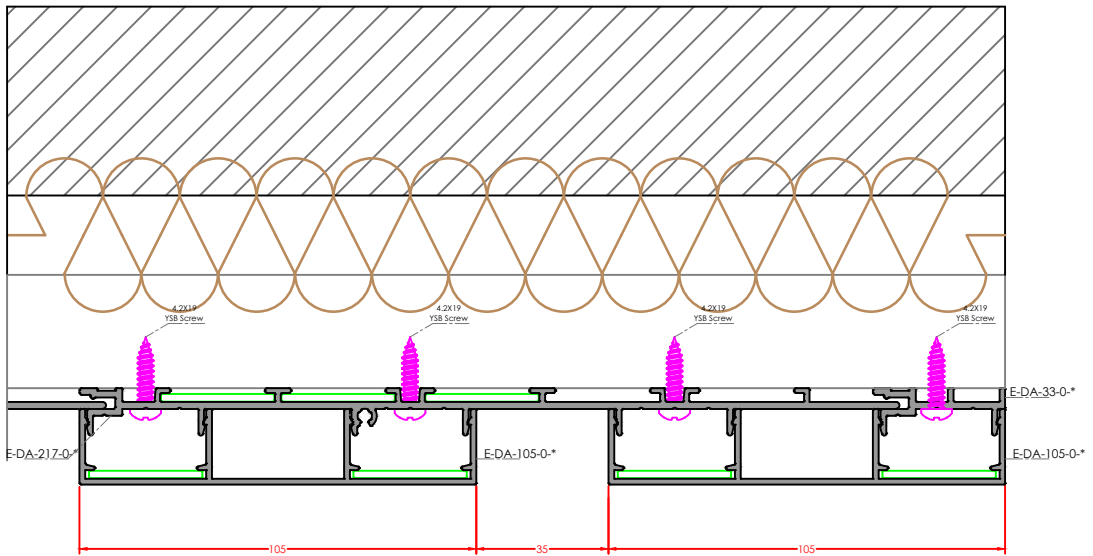

OUTSIDE

* The selected color must be specified.

TRANSITIONAL COVERED VERTICAL DETAIL

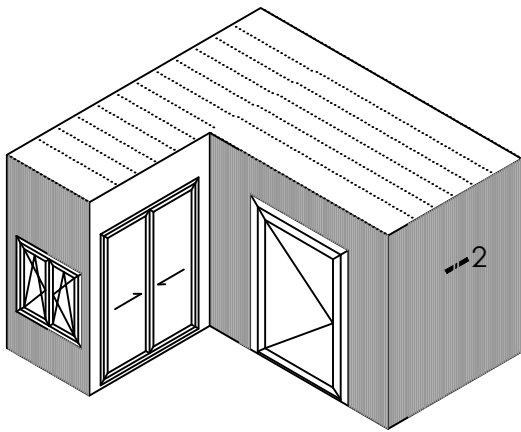

INSIDE

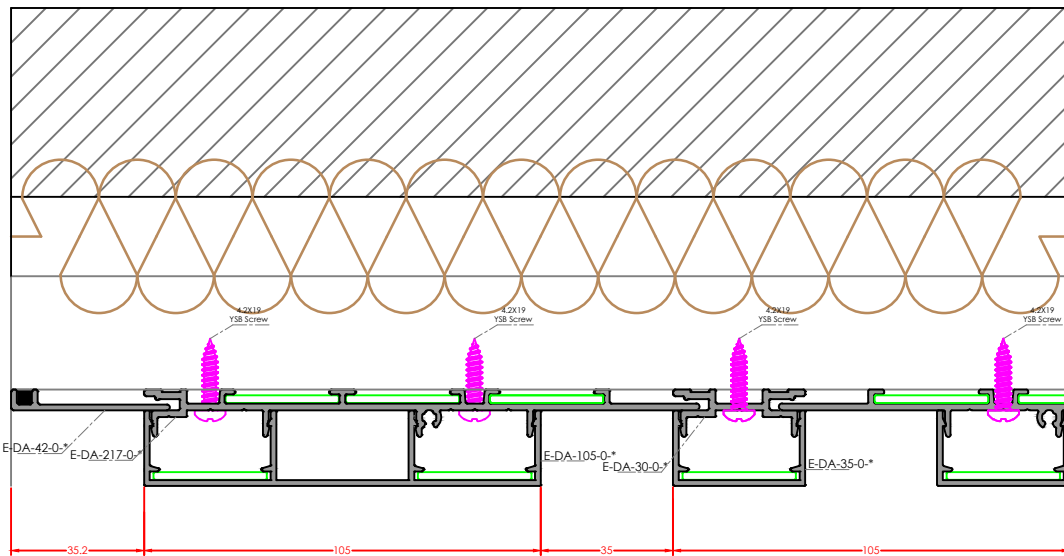

OUTSIDE

* The selected color must be specified.

ALUMINIUM WINDOW SYSTEM TRANSITION VERTICAL DETAIL

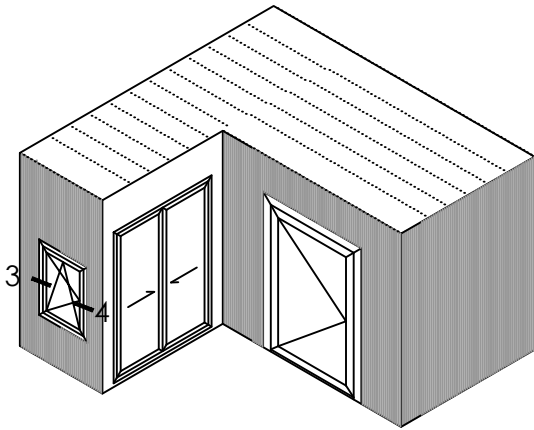

INSIDE

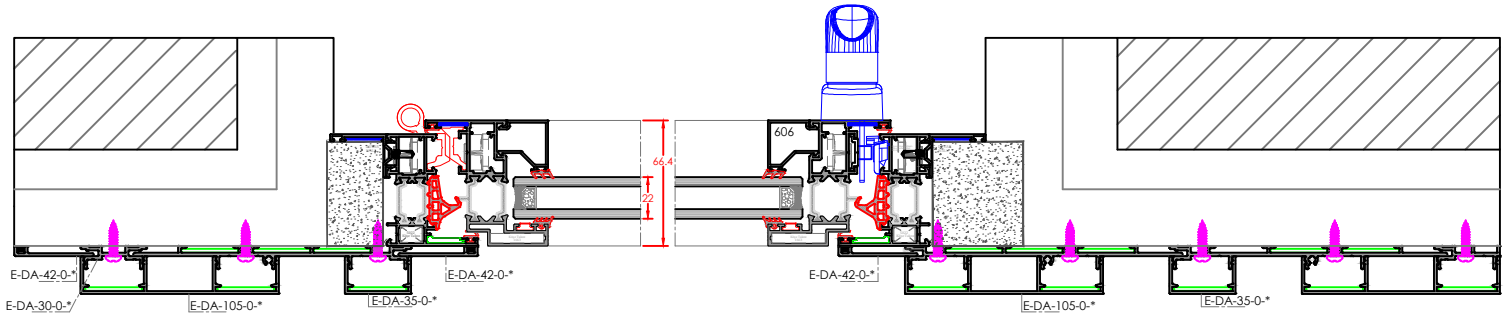

OUTSIDE

* The selected color must be specified.

OUTWARD COVERED DETAIL

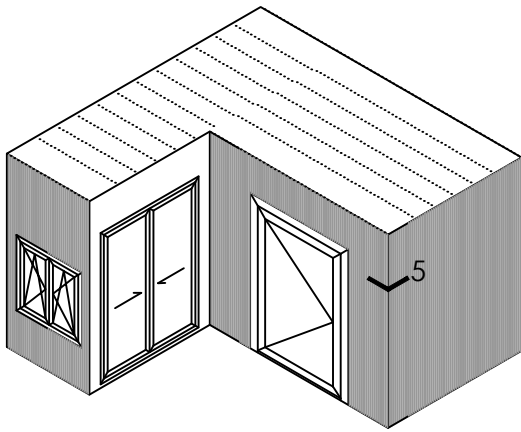

INSIDE

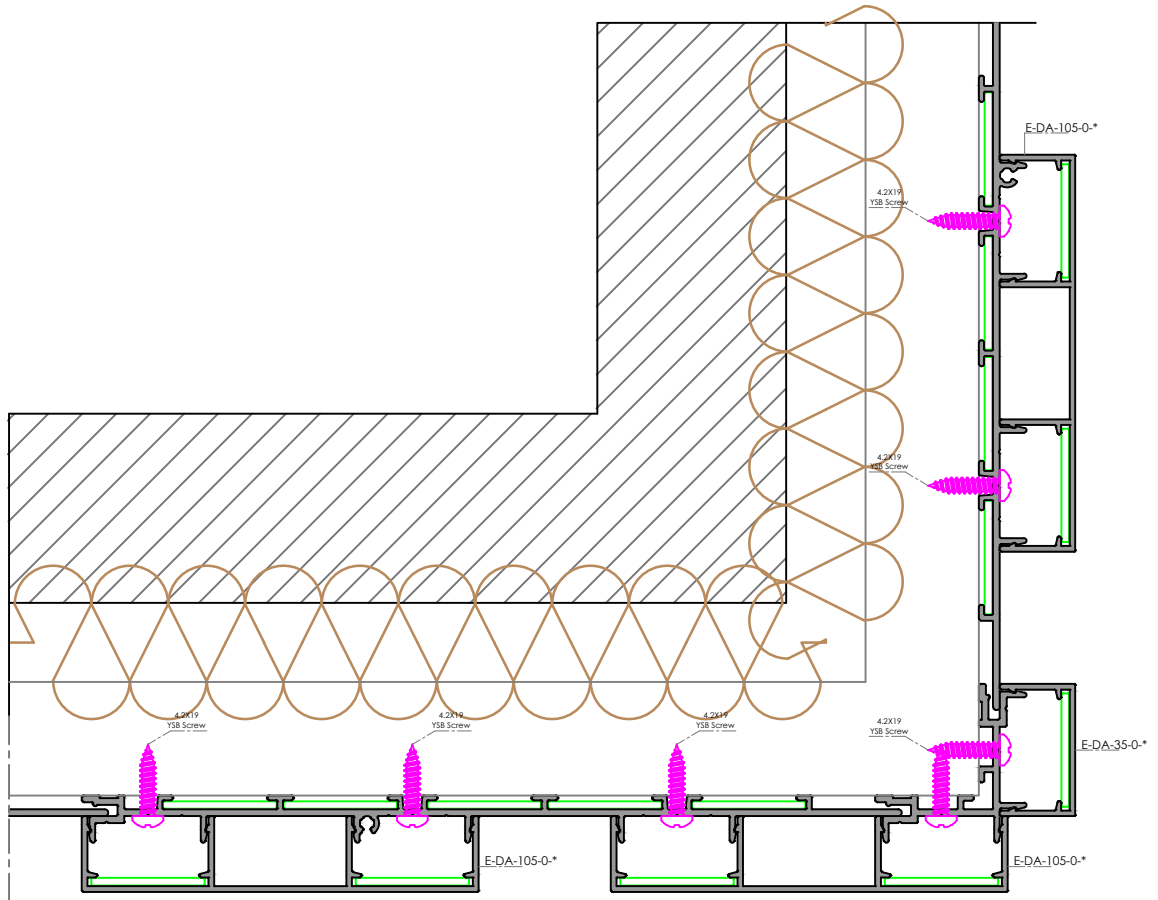

OUTSIDE

* The selected color must be specified.

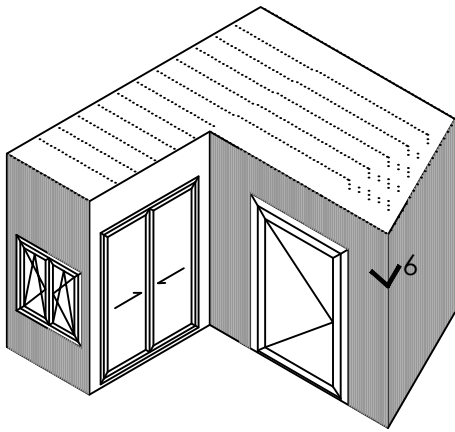

INSIDE

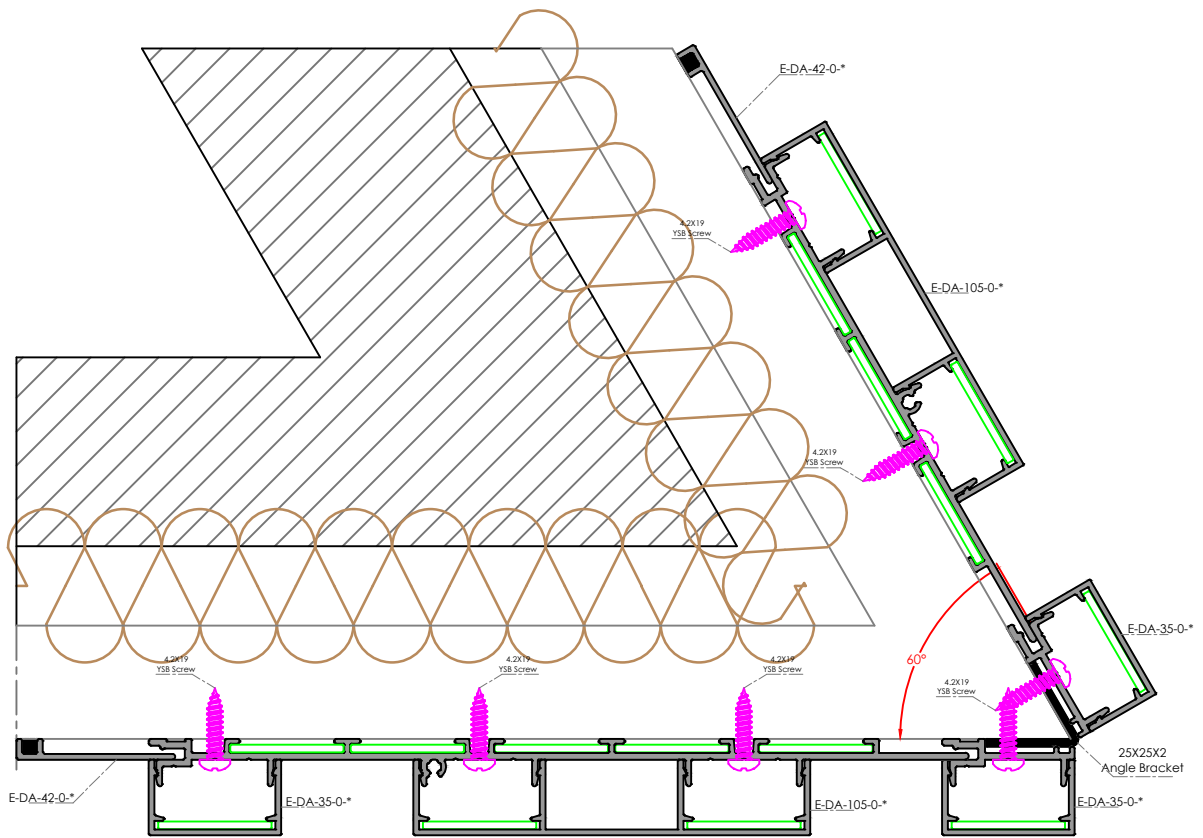

OUTSIDE

* The selected color must be specified.

INWARD COVERED DETAIL

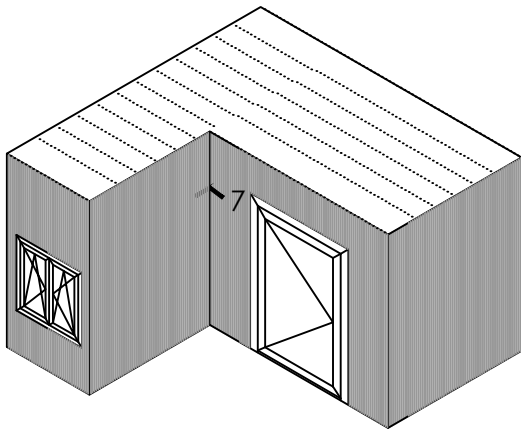

INSIDE

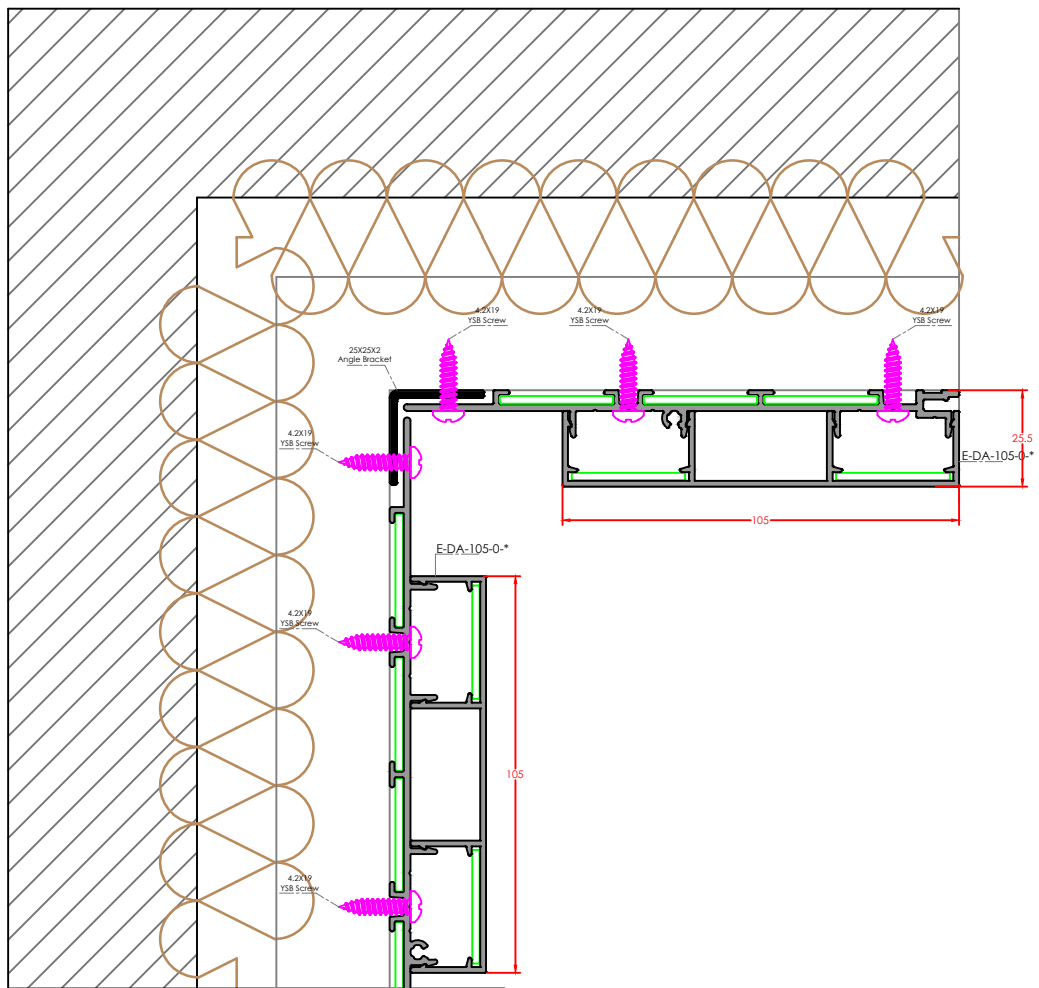

OUTSIDE

* The selected color must be specified.



www.tgpsystems.com

DECOAL SERIES

75 COVERED FUNCTIONS

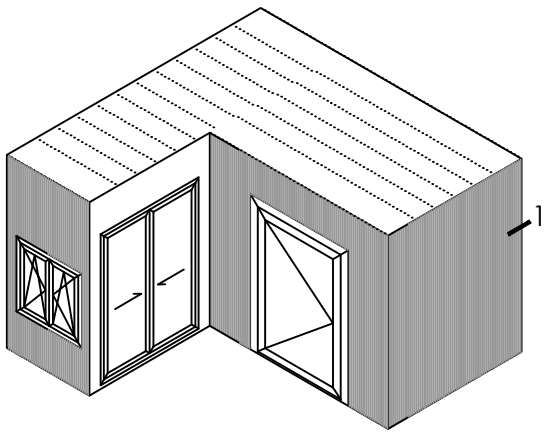

INSIDE

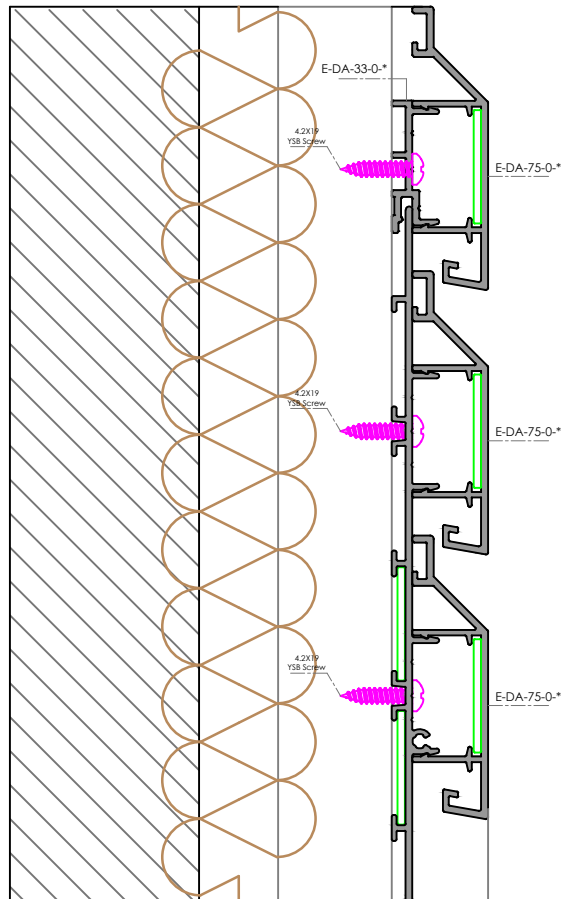

OUTSIDE

* The selected color must be specified.

TRANSITIONAL COVERED VERTICAL DETAIL

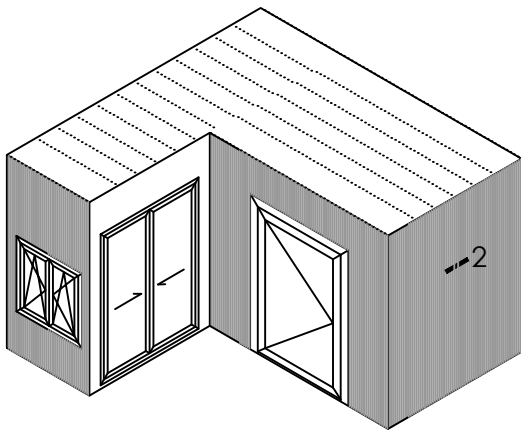

INSIDE

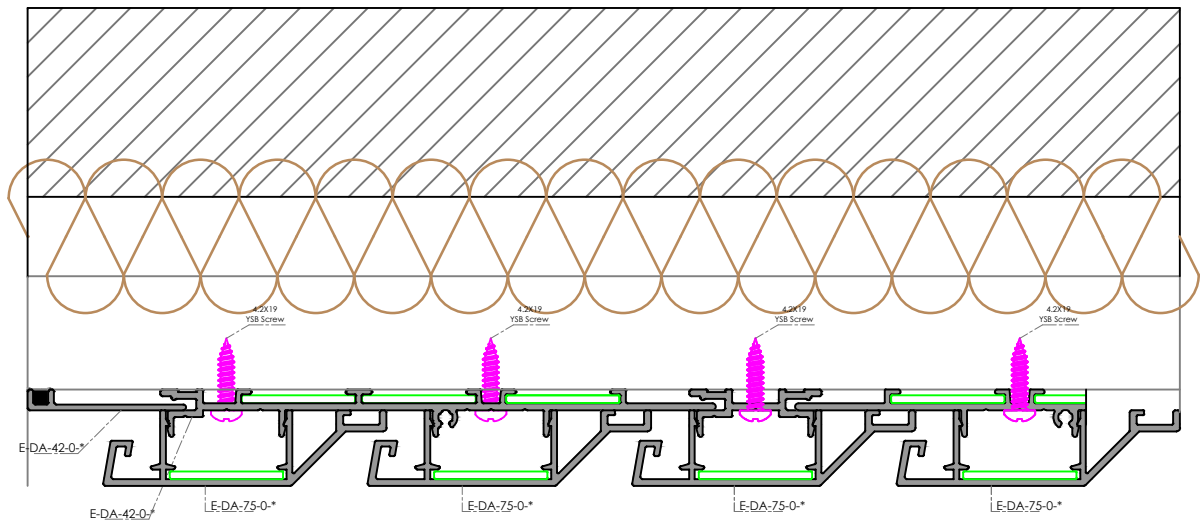

OUTSIDE

* The selected color must be specified.

ALUMINIUM WINDOW SYSTEM TRANSITION VERTICAL DETAIL

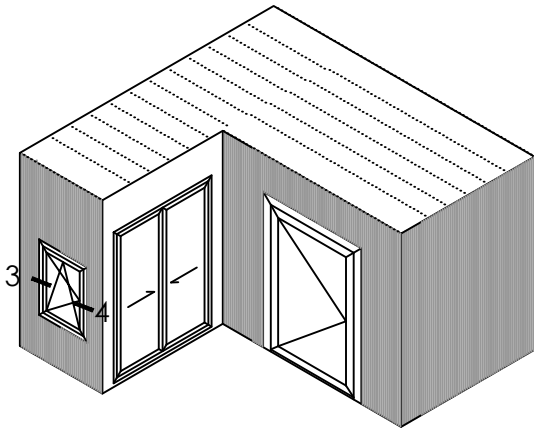

INSIDE

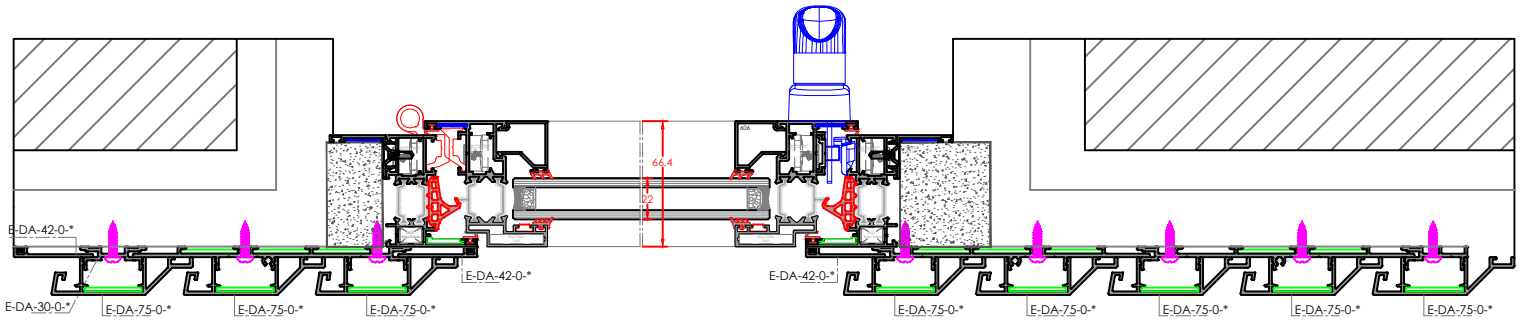

OUTSIDE

* The selected color must be specified.

OUTWARD COVERED DETAIL

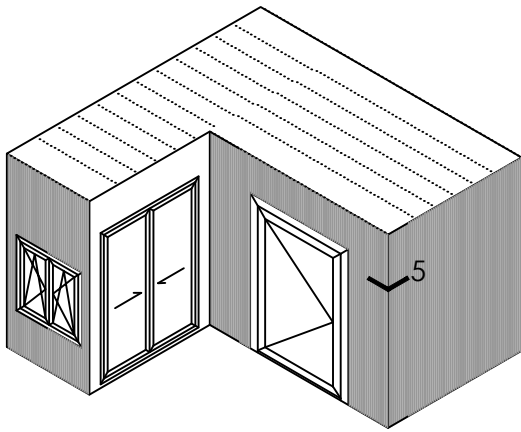

INSIDE

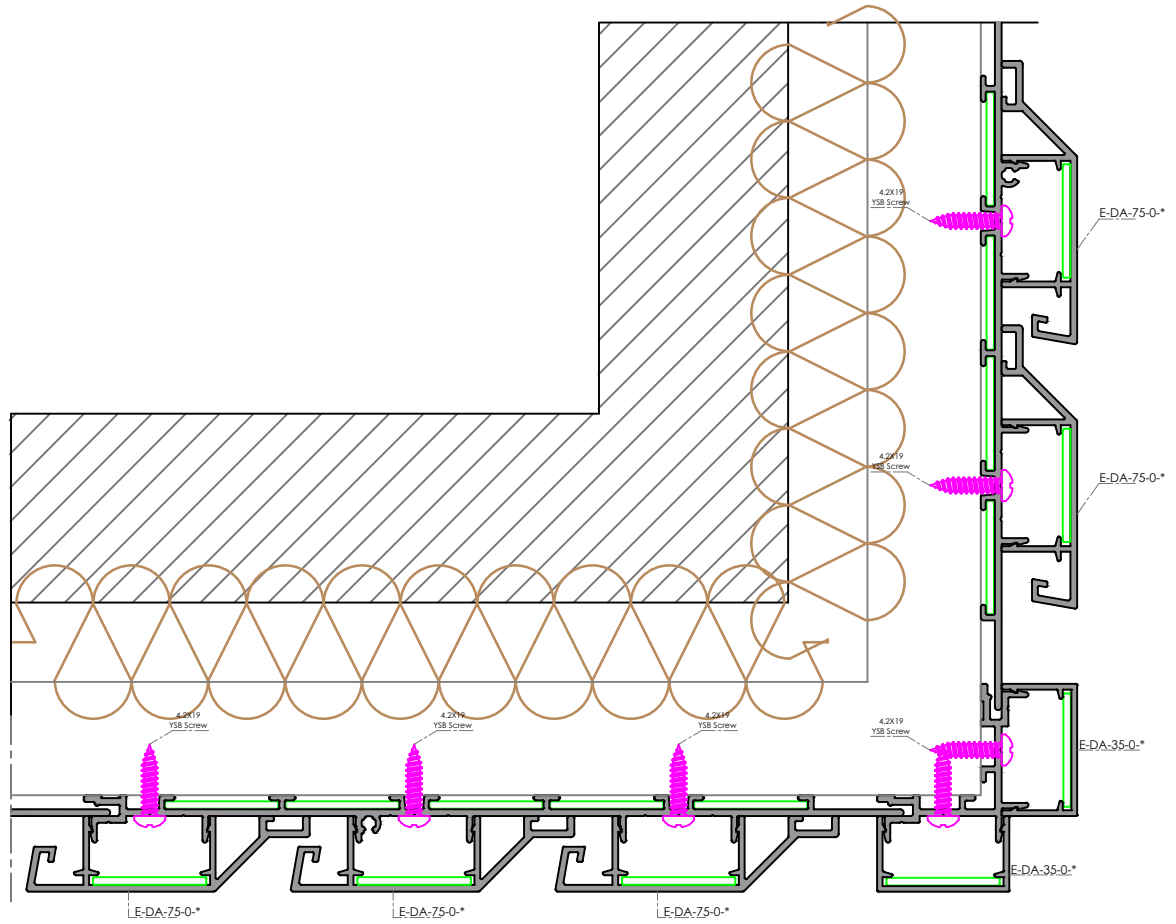

OUTSIDE

* The selected color must be specified.

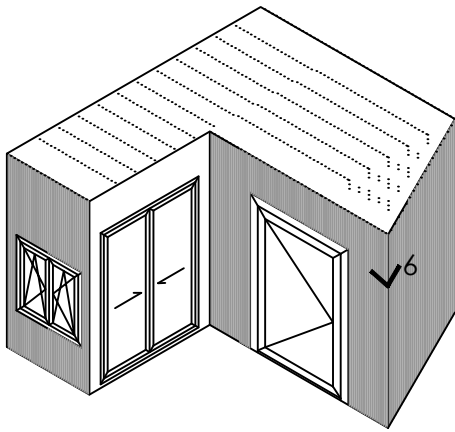

INSIDE

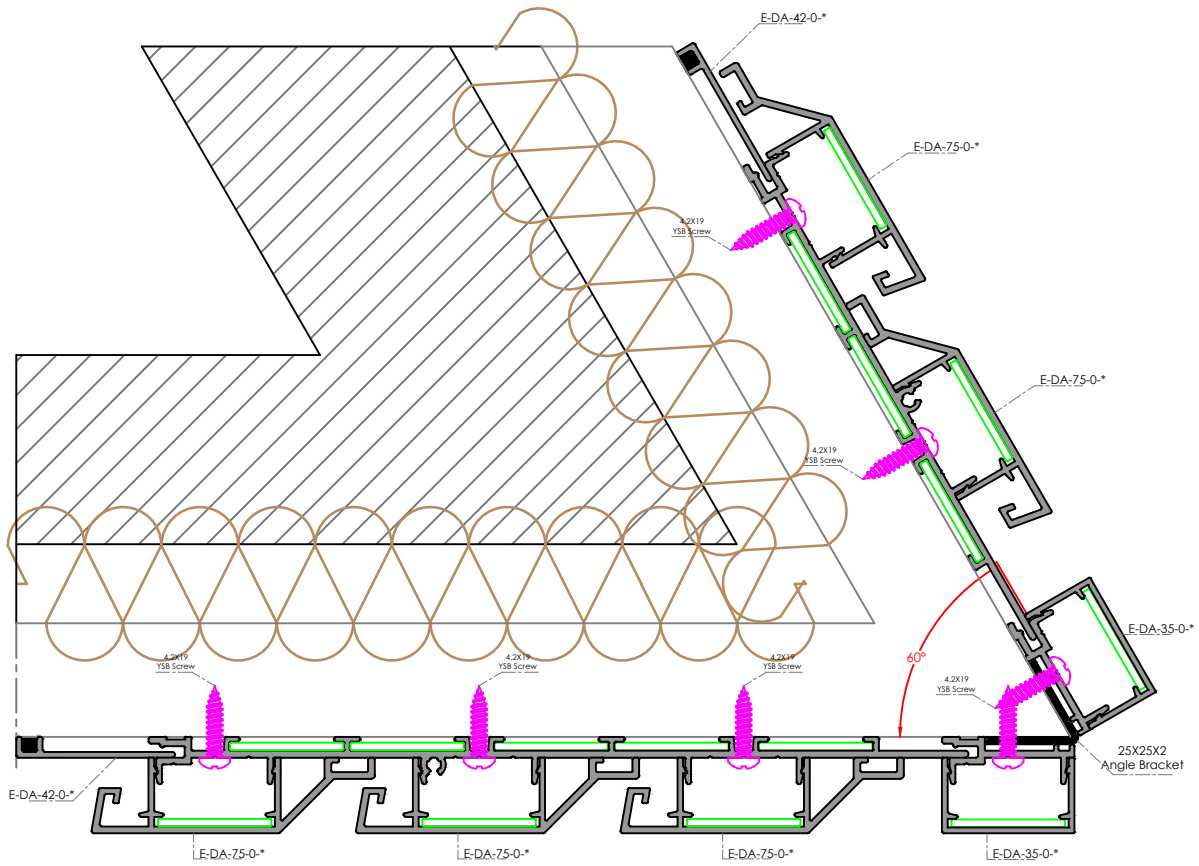

OUTSIDE

* The selected color must be specified.

INWARD COVERED DETAIL

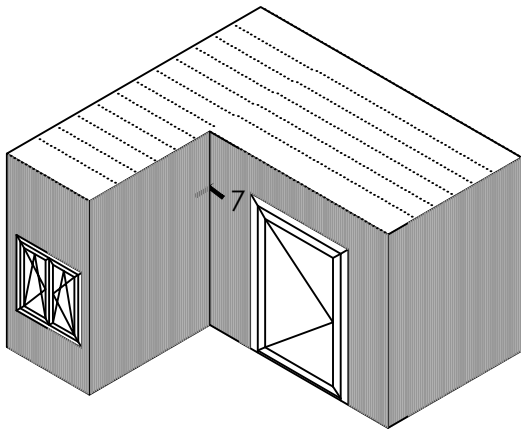

INSIDE

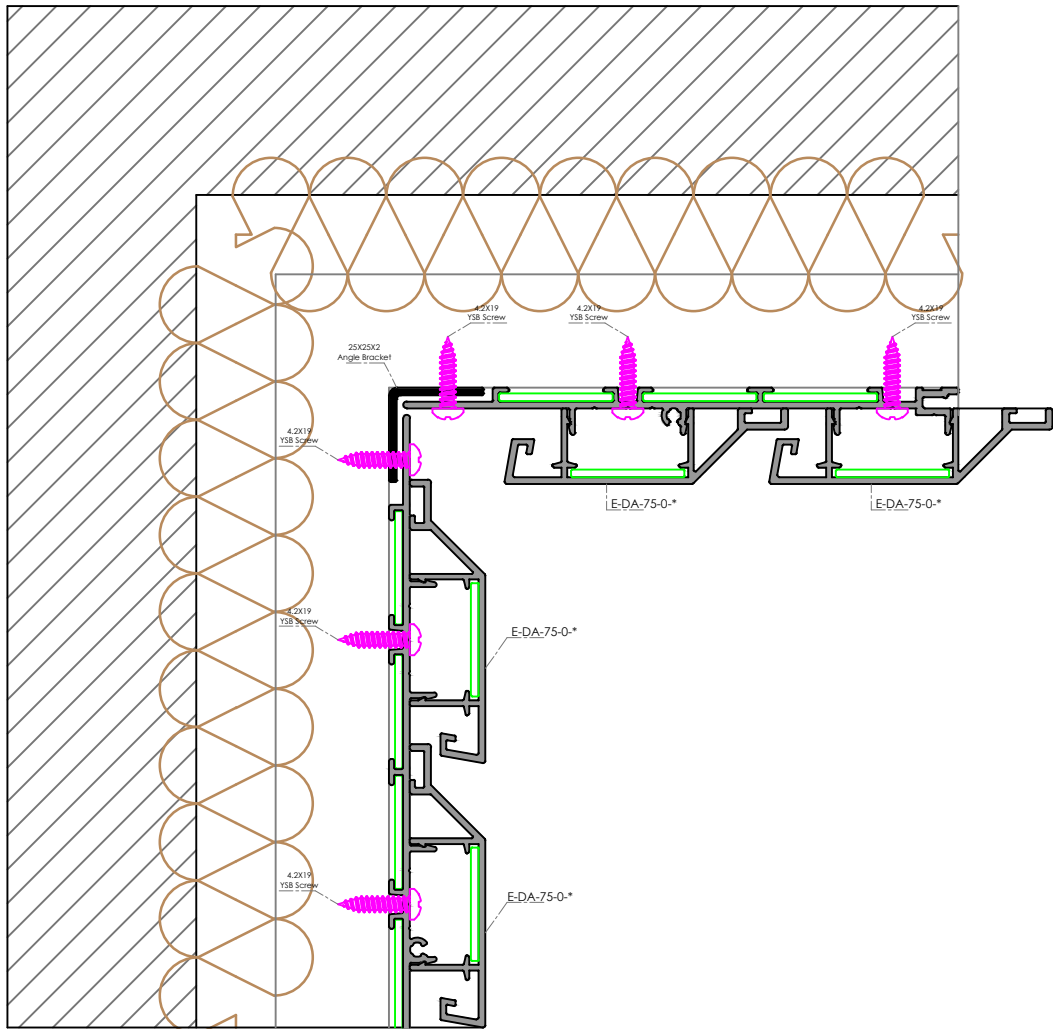

OUTSIDE

* The selected color must be specified.



www.tgpsystems.com